

PARTY LINE

TENT RENTALS
partylinerentals.com • 914-592-1200

RENTAL CATALOG 2024-2025



TENTS | TABLES | CHAIRS | CHINA

WEDDINGS | SOCIAL | PRODUCTIONS | CORPORATE

(914) 592-1200 | 1 NEPPERHAN AVENUE ELMSFORD NY 10523

TO OUR CUSTOMERS...

IT IS OUR GOAL THAT OUR CATALOG WILL HELP GUIDE YOU IN THE SELECTION OF RENTAL EQUIPMENT YOU WILL NEED. PLEASE KEEP IN MIND THAT THIS CATALOG DOES NOT REPRESENT OUR TOTAL INVENTORY, BUT IT IS A SMALL DEPICTION OF THE HUNDREDS OF NEW AND USED ITEMS WE HAVE AVAILABLE. SO, IF YOU DON'T SEE WHAT YOU NEED, PLEASE GIVE US A CALL TODAY!
SINCERELY, KARIN PUFF, PRESIDENT, PARTY LINE RENTALS

SOME THINGS YOU SHOULD KNOW

Rental Rates: Rental rates are listed on the front side of the contract. Rates are nonnegotiable. Daily rentals are based on a 24-Hours period. Weekly rates are based upon 40hr. week and 160 hr. month. Rental rates do not include Fuel.

Dirty, Damaged or Lost Equipment: Customer agrees to pay for any damage to or loss of the goods, including loss of rental as an insurer, regardless of cause, except for reasonable wear and tear, while goods are out of the possession of PLR. Customer agrees to pay a reasonable cleaning charge for rental items returned dirty or coated by other. ALL China, Glassware, Serving ware, and Flatware must be returned *Food Free and Rinsed*. Linens must also be Food Free, Dry and Folded. Wet and Mildewed linens are considered damaged beyond repair. Accrued rental charges cannot be applied against the purchase or cost of repair of damaged, lost or stolen goods. Equipment lost, stolen or damaged beyond repair will be paid for at its current list price plus any transportation charges. The cost of repairs will be borne by the customer, whether performed by PLR, or at PLR's option, by others.

Times of Return and Late Return: Customer's right of possession terminates on the rental period "Due In" date and time. And retention of possession after this time constitutes a material breach of this contract. Time is the essence of this contract. Any extension must be mutually agreed upon in writing. Customer agrees to return the rented items during PLR's regular business hours Customer agrees that if the rented items are held beyond the expiration of the rental period overtime charges will accrue and be charged as overtime upon return and closing of this contract..

Time of Payment: All rentals are to be paid in advance. Open accounts are due and payable net 30 days from date of invoice. **Deposit:** To reserve any rental item a non-refundable deposit is required. Reservations will be honored at time of receipt of the non-refundable deposit and a signed contract and is subject equipment availability at time contract and deposit is received by PLR. **Security Deposits** are deemed as appropriate by PLR All past due invoices carry a finance charge of 1.5% per month (annual rate of 18%).

Identification: Customer agrees that our identifying marks, including company name and or logos may appear on rented items while in your possession. Removal of such, by the customer, will result in extra charges.

Delivery and Pickup Terms: PLR does not warrant or guarantee an exact delivery time and will not be held liable for any delays or additional expenses incurred for any delays for any reason beyond our control. Delivery site must be reasonably safe, secure & accessible. Customer agrees to assume all risk of loss, damage or destruction between drop-off & possession should someone not be present on jobsite upon delivery All rented items scheduled for pickup shall be ready for pickup in the same manner as delivered. i.e. stacked, bagged or boxed. Extra charges will be accessed for any additional labor or cleaning required by PLR. Customer is responsible and accepts all risks for rental items in your possession until PLR picks up. Any items left within assets upon return are deemed abandoned/surrendered with no PLR liability for these items.

Damage Waiver Charge (DWC): If the customer accepts DWC, PLR agrees to waive any claim against customer for ACCIDENTAL DAMAGE to equipment rented under this contract. DWC does not cover ABUSE, VANDALISM or THEFT. DWC is not insurance and customer liability is limited to 20% of the replacement cost of the equipment damaged beyond repair. DWC does not cover tire damage, flat tires or any exclusion listed on a rented item listed on the front side of this contract. Damaged equipment does not relieve your obligations of this contract; all rental fees are due and payable in full.

SAFETY and INSTRUCTION: Proper and safe use is the responsibility of the operator. Customer is solely responsible to observe and follow all safety rules and regulations required by any local, state or government agency and to provide all protective and fall prevention equipment. The customer also acknowledges that they are qualified to use items rented.

Insurance: Customer shall maintain, at their expense, liability, property and casualty insurance coverage in the amounts necessary to fully protect PLR and our equipment against any claims, loss or damage of whatever nature or type.

Permits and Licenses: Customer agrees to obtain at their expense, and provide a copy of, prior to the installation, all necessary permits, licenses or permission required for the event. PLR will furnish any additional information required to obtain the permit i.e. Certificate of Flame Retardancy and other.

VISIT OUR DESIGN CENTER TO START PLANNING YOUR EVENT TODAY!
1 NEPPERHAN AVENUE ELMSFORD, NY 10523 | (914) 592-1200
OUR DESIGN CENTER IS AVAILABLE ONLINE AT PARTYLINERENTALS.COM



TABLE OF CONTENTS

<u>TENTS</u>	<u>4-5</u>	<u>UTENSILS</u>	<u>60</u>
<u>FIESTA FRAME</u>	<u>6</u>	<u>TABLE DÉCOR</u>	<u>61</u>
<u>HIGH PEAK</u>	<u>7</u>	<u>KITCHEN AND CATERING</u>	<u>62</u>
<u>CLEAR-TOP</u>	<u>8</u>	<u>BEVERAGE AND COFFEE</u>	<u>63</u>
<u>NAVI-TRAC</u>	<u>9</u>	<u>CHAFING DISHES</u>	<u>64</u>
<u>STRUCTURE</u>	<u>10</u>	<u>FOOD STORAGE</u>	<u>65</u>
<u>CENTURY TENSION</u>	<u>11</u>	<u>FOOD WARMING</u>	<u>65</u>
<u>SAILCLOTH</u>	<u>12</u>	<u>SERVING TRAYS</u>	<u>66</u>
<u>MARQUEE</u>	<u>13</u>	<u>SERVING UTENSILS</u>	<u>67</u>
<u>OTHER STYLE TENTS</u>	<u>14</u>	<u>POTS & PANS</u>	<u>68</u>
<u>PARTY PACKAGES</u>	<u>15</u>	<u>TIERED STANDS</u>	<u>69</u>
<u>TENT UPGRADES</u>	<u>16-18</u>	<u>TRAYS</u>	<u>69</u>
<u>GET INSPIRED</u>	<u>19</u>	<u>COOKING EQUIPMENT</u>	<u>70-71</u>
<u>FIRE AND SAFETY</u>	<u>20-21</u>	<u>SANITATION</u>	<u>72</u>
<u>TENT LIGHTING</u>	<u>22</u>	<u>WAITER & BUSBOY</u>	<u>73</u>
<u>UPLIGHTING</u>	<u>23</u>	<u>BAR AND BARWARE</u>	<u>74</u>
<u>SPECIALTY</u>	<u>24</u>	<u>MODULAR FLASH BAR</u>	<u>75</u>
<u>STRING</u>	<u>25</u>	<u>BARWARE COLLECTION</u>	<u>76</u>
<u>CHANDELIER</u>	<u>25</u>	<u>ROLLING BARS</u>	<u>77</u>
<u>OUTDOOR</u>	<u>26-27</u>	<u>FURNITURE AND DÉCOR</u>	<u>78</u>
<u>DANCE FLOOR TENT FLOORING CARPET STAGING</u>	<u>28-29</u>	<u>ARCH'S</u>	<u>79</u>
<u>DANCE FLOOR</u>	<u>30</u>	<u>FURNITURE</u>	<u>80-81</u>
<u>TENT FLOORING</u>	<u>31-33</u>	<u>CLIMATE CONTROL</u>	<u>82-83</u>
<u>CUSTOM FLOORING</u>	<u>34</u>	<u>COOLING</u>	<u>84</u>
<u>CARPET</u>	<u>35</u>	<u>AIR CONDITIONING</u>	<u>85</u>
<u>STAGING</u>	<u>36-37</u>	<u>PATIO HEATERS</u>	<u>86</u>
<u>TIERED STAGING</u>	<u>38</u>	<u>UMBRELLAS</u>	<u>86</u>
<u>BLEACHERS</u>	<u>39</u>	<u>HEATING</u>	<u>87</u>
<u>TABLES</u>	<u>40</u>	<u>POWER CONTROL</u>	<u>88</u>
<u>RECTANGULAR</u>	<u>41</u>	<u>GENERATORS</u>	<u>89</u>
<u>ROUND</u>	<u>42</u>	<u>CONCESSION EQUIPMENT</u>	<u>90-93</u>
<u>FOLDING</u>	<u>43</u>	<u>FILM AND TV PRODUCTION</u>	<u>94-95</u>
<u>COCKTAIL "HIGH-TOP" TABLE</u>	<u>43</u>	<u>A/V EQUIPMENT</u>	<u>96</u>
<u>RUSTIC COLLECTION</u>	<u>44</u>	<u>CROWD CONTROL</u>	<u>97</u>
<u>LINENS</u>	<u>45-47</u>	<u>STANCHIONS</u>	<u>98</u>
<u>CHAIRS</u>	<u>48-50</u>	<u>PIPE AND DRAPE</u>	<u>98</u>
<u>KIDS CORNER</u>	<u>51</u>	<u>ACCESSORIES</u>	<u>99</u>
<u>CHINA COLLECTION</u>	<u>52-57</u>	<u>EVENT SUPPLIES</u>	<u>100</u>
<u>GLASSWARE</u>	<u>58-59</u>	<u>EQUIPMENT</u>	<u>101</u>

HOW TO PICK THE RIGHT TENT FOR YOUR EVENT

WHEN SELECTING A TENT, CONSIDER THE FOLLOWING FACTORS:

- **TYPE OF EVENT:** WHETHER IT'S A WEDDING PARTY, CORPORATE FUNCTION, BACKYARD CELEBRATION OR TV AND FILM PRODUCTION
- **GUEST COUNT:** ESTIMATE THE NUMBER OF GUESTS TO DETERMINE THE TENT SIZE.
- **LOCATION:** CONSIDER THE EVENT LOCATION, GROUND SURFACE, AND LOCAL WEATHER CONDITIONS. SITE-CHECKS ARE OFFERED TO HELP DETERMINE THE TOTAL SIZE OF THE TENT THAT WILL FIT IN THE EVENT'S SPACE.

HOW DO I DETERMINE THE RIGHT TENT SIZE FOR MY EVENT?

CALCULATE THE TENT SIZE BY CONSIDERING THE NUMBER OF GUESTS, SEATING ARRANGEMENT, AND ANY ADDITIONAL SPACE NEEDED FOR DANCE FLOORS, STAGES, OR BUFFETS. CONSULT WITH OUR TENT SPECIALIST OR VISIT OUR SHOWROOM DESIGN CENTER TO ENSURE YOU SELECT THE APPROPRIATE SIZE FOR YOUR EVENT.

WHAT TENT ACCESSORIES MIGHT I NEED FOR MY EVENT?

ACCESSORIES CAN ENHANCE YOUR EVENT EXPERIENCE. CONSIDER ITEMS LIKE SIDEWALLS, LIGHTING, FLOORING, HEATING OR COOLING SYSTEMS, TENT LINERS, TENT DOORS, AND DECORATIONS TO CREATE THE DESIRED ATMOSPHERE.

ARE THERE ANY SAFETY CONSIDERATIONS WHEN CHOOSING A TENT?

ENSURE THAT THE TENT MEETS SAFETY STANDARDS AND LOCAL REGULATIONS. CONSIDER FACTORS LIKE ANCHORING, FIRE SAFETY, AND EMERGENCY EXITS.

HOW TO CALCULATE TENT SPACE REQUIREMENTS FOR YOUR EVENT

THEATER SEATING *IF ARRANGING CHAIRS IN A ROW	6-8 SQ. FT PER GUEST
BANQUET SEATING	15 SQ. FT PER GUEST *RECTANGULAR TABLES 15 SQ. FT PER GUEST *ROUND TABLE SEATING 6 8 10 12
COCKTAIL-STYLE RECEPTIONS	6-8 SQ. FT PER GUEST *NO SEATING 8-10 SQ. FT PER GUEST *SEATING
DANCE AREA	2-4 SQ. FT PER GUEST
BAR AREA	100 SQ. FT
BUFFET AREA	100 SQ. FT FOR EACH TABLE
BAND PIANO	100 SQ. FT

PLAN WITH OUR TENT CALCULATOR!





WITH OVER 35 YEARS OF RENTAL EXPERIENCE, PARTY LINE RENTALS IS SURE TO HAVE THE STYLE AND SIZE TENT RENTAL YOU NEED FOR YOUR NEXT EVENT OR PARTY! WE'VE MASTERED THE ART OF BOTH INDOOR AND OUTDOOR PARTIES WITH PROMPT, DEPENDABLE SERVICE, HIGH-QUALITY TENT RENTALS AND STYLIZED ACCESSORIES.

AT PARTY LINE RENTALS, WE MAKE IT EASY TO DETERMINE THE SIZE TENT RENTAL YOU'LL NEED FOR YOUR EVENT. WE TAKE CARE OF EVERYTHING FROM DELIVERY AND INSTALLATION TO TENT TEAR-DOWN AND LAST-MINUTE EMERGENCY NEEDS.



TENTS



TURN OUR TENT INTO YOUR BLANK CANVAS AND WATCH YOUR CREATIVE VISION COME TO LIFE!

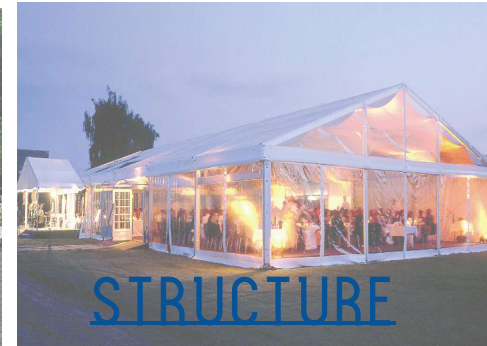

FIESTA FRAME



STRENGTH AND STURDINESS: FIESTA FRAME TENTS ARE KNOWN FOR THEIR REMARKABLE STRENGTH & DURABILITY, MAKING THEM AN EXCELLENT CHOICE FOR ALL EVENTS FROM BACKYARD TO CORPORATE TO SOCIAL.

FRAME STRUCTURE: HEAVY-DUTY VINYL TOP STRETCHED OVER METAL FRAME, ELIMINATING THE NEED FOR A CENTER POLE.

ADJUSTABLE HEIGHT: STANDARD LEGS ARE ADJUSTABLE, RANGING FROM 7' TO 10' & CAN BE EXTENDED TO OVER 12' TO ACCOMMODATE VARIOUS EVENT SETUPS.

SECURE INSTALLATION: SECURELY ANCHORED ON GRASS USING STAKES OR CONCRETE WEIGHT BALLASTS.

VARIETY OF SIZES & CONFIGURATIONS: WIDE RANGE OF SIZE OPTIONS, WITH WIDTHS RANGING FROM 10 FT TO 30 FT.

CUSTOM INSTALLATIONS AVAILABLE: WHETHER YOU REQUIRE A UNIQUE LAYOUT, ADDITIONAL FEATURES, OR SPECIAL ARRANGEMENTS, CUSTOMIZATION IS POSSIBLE TO ENSURE A TAILORED SOLUTION.

MATERIAL CHOICES: WHITE, CLEAR, BLACK, AND EVEN PINK VINYL (AVAILABLE IN SELECT SIZES).

MOST POPULAR TENT SIZES

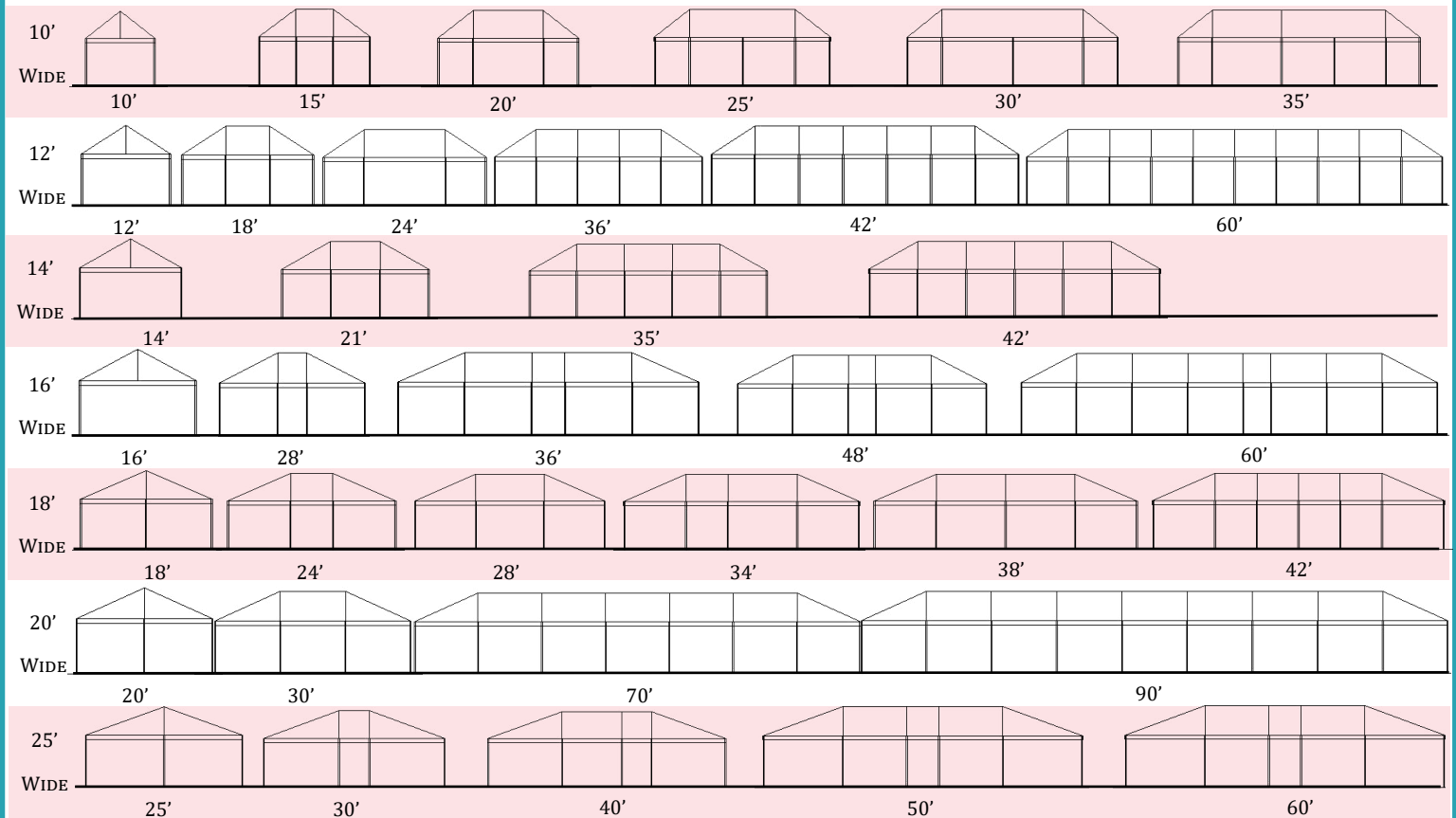

WITH THEIR EYE-CATCHING DESIGN AND PRACTICALITY, OUR HIGH PEAK TENTS ARE PERFECT FOR WEDDINGS, CORPORATE EVENTS, OUTDOOR PARTIES, AND MORE. THEY CREATE A STRIKING FOCAL POINT AND PROVIDE A COMFORTABLE SPACE FOR YOUR GUESTS TO ENJOY.

ELEGANT DESIGN: THE GRACEFUL LINES AND HIGH PEAK TENSION TOP OF OUR TENTS ADD A TOUCH OF ELEGANCE TO ANY EVENT, MAKING A LASTING IMPRESSION ON YOUR GUESTS.

SPACIOUS INTERIOR: OUR HIGH PEAK TENTS OFFER A SPACIOUS INTERIOR THAT PROVIDES AN EASY AND SOPHISTICATED ATMOSPHERE FOR YOUR EVENT. WHETHER IT'S A DAYTIME GATHERING OR AN EVENING CELEBRATION, OUR TENTS SET THE STAGE FOR A MEMORABLE EXPERIENCE.

HIGH PEAK CENTER MAST: THESE TENTS ARE INTELLIGENTLY DESIGNED WITH A HIGH PEAK CENTER MAST THAT MAXIMIZES USABLE SPACE UNDERNEATH. THIS ELIMINATES THE NEED FOR INTERIOR FRAMES OR SUPPORT POLES, CREATING A CLEAR AND UNOBSTRUCTED SPACE.

COLOR OPTIONS: OUR HIGH PEAK TENTS ARE AVAILABLE IN CLASSIC AND VERSATILE WHITE VINYL, ALLOWING YOU TO MATCH YOUR EVENT'S THEME AND DECOR.

SIZE VARIETY: CHOOSE FROM A RANGE OF SIZES TO SUIT YOUR SPECIFIC NEEDS, INCLUDING 10'x10', 10'x20', 16'x16', 20'x20', 20'x30', AND 20'x40'. NO MATTER THE SIZE OF YOUR EVENT, WE HAVE A HIGH PEAK TENT TO ACCOMMODATE YOUR REQUIREMENTS.

MOST POPULAR TENT SIZES:

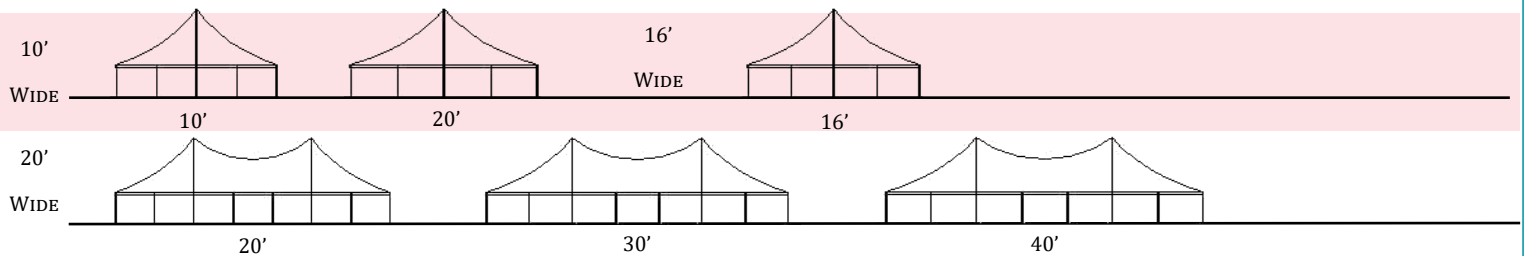

CLEAR TOP

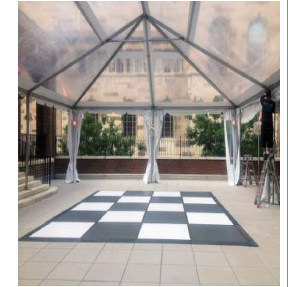

OPEN SPACE AESTHETICS: CLEAR TOP TENTS OFFER A UNIQUE SOLUTION, MAINTAINING THE SENSE OF OPEN SPACE WHILE ALLOWING NATURAL LIGHT TO FILTER IN, CREATING AN INVITING ATMOSPHERE. ENJOY AN UNOBSTRUCTED VIEW OF THE SKY, WHICH ADDS TO THE AMBIANCE OF YOUR EVENT, WHETHER IT'S A DAYTIME OR NIGHTTIME AFFAIR.

AVAILABLE SIZES & TYPES: CHOOSE FROM A RANGE OF SIZES, WITH CLEAR TOP TENTS AVAILABLE IN WIDTHS RANGING FROM 20' UP TO 60', PROVIDING FLEXIBILITY FOR VARIOUS EVENT SIZES AND LAYOUTS. AVAILABLE IN FIESTA & NAVI STYLE TENTS.

TEMPERATURE CONSIDERATION: PLEASE NOTE THAT CLEAR TOP TENTS CAN BECOME QUITE WARM DURING DAYTIME EVENTS DUE TO DIRECT SUNLIGHT. IT'S ADVISABLE TO USE THEM PRIMARILY FOR NIGHTTIME EVENTS TO MAXIMIZE COMFORT FOR YOUR GUESTS.

MOST POPULAR TENT SIZES:

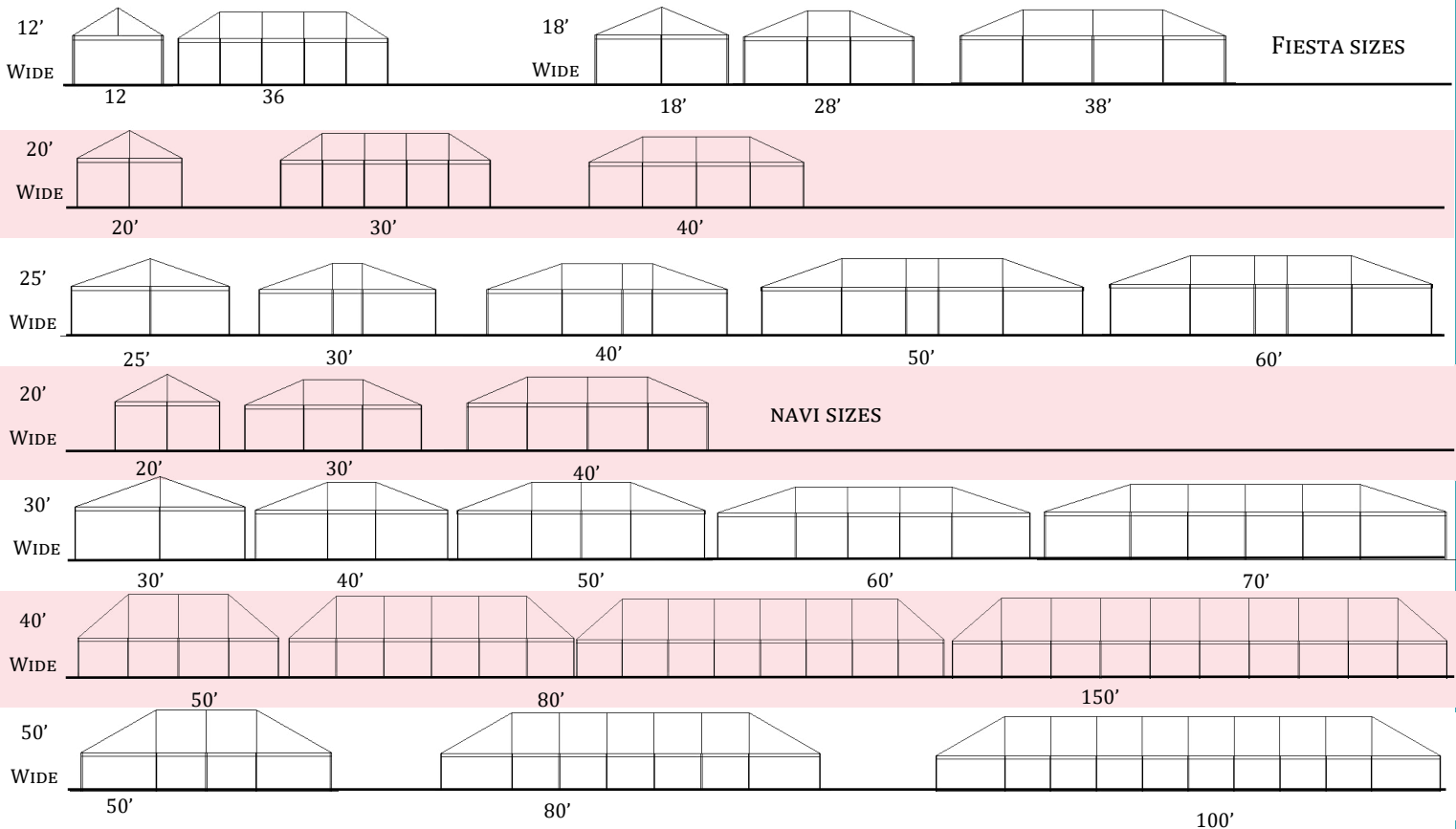

ENHANCED STABILITY: NAVI-TRAC FRAME TENTS FEATURE A LARGER FRAMEWORK DESIGNED FOR HIGHER STABILITY AND AN INCREASED WIND RATING, ENSURING A SECURE AND SAFE EVENT ENVIRONMENT.

ALL-WEATHER PERFORMANCE: THE HEAVY-DUTY BLOCK OUT VINYL USED IN NAVI-TRAC TENTS HELPS RETAIN COOL AIR IN THE SUMMER AND WARMTH IN THE WINTER, MAKING THEM SUITABLE FOR VARIOUS WEATHER CONDITIONS.

CERTIFIED ENGINEERING: NAVI-TRAC FRAME TENTS ARE ENGINEERED AND CERTIFIED, PROVIDING PEACE OF MIND FOR THE SAFETY OF YOUR EVENT AND GUESTS.

ADJUSTABLE HEIGHT: STANDARD LEGS ARE ADJUSTABLE, RANGING FROM 8' TO 10', AND WITH EXTENSIONS, THEY CAN REACH OVER 12', ALLOWING CUSTOMIZATION TO SUIT YOUR EVENT NEEDS.

VINYL OPTIONS: THESE TENTS ARE AVAILABLE IN EITHER WHITE OR CLEAR VINYL, OFFERING FLEXIBILITY IN DESIGN AND LIGHTING OPTIONS.

SECURE INSTALLATION: NAVI-TRAC FRAME TENTS CAN BE EASILY & SECURELY ANCHORED ON GRASS WITH STAKES OR ON CONCRETE USING CONCRETE WEIGHT BALLASTS, ENSURING A STABLE SETUP REGARDLESS OF THE LOCATION.

MOST POPULAR TENT SIZES:

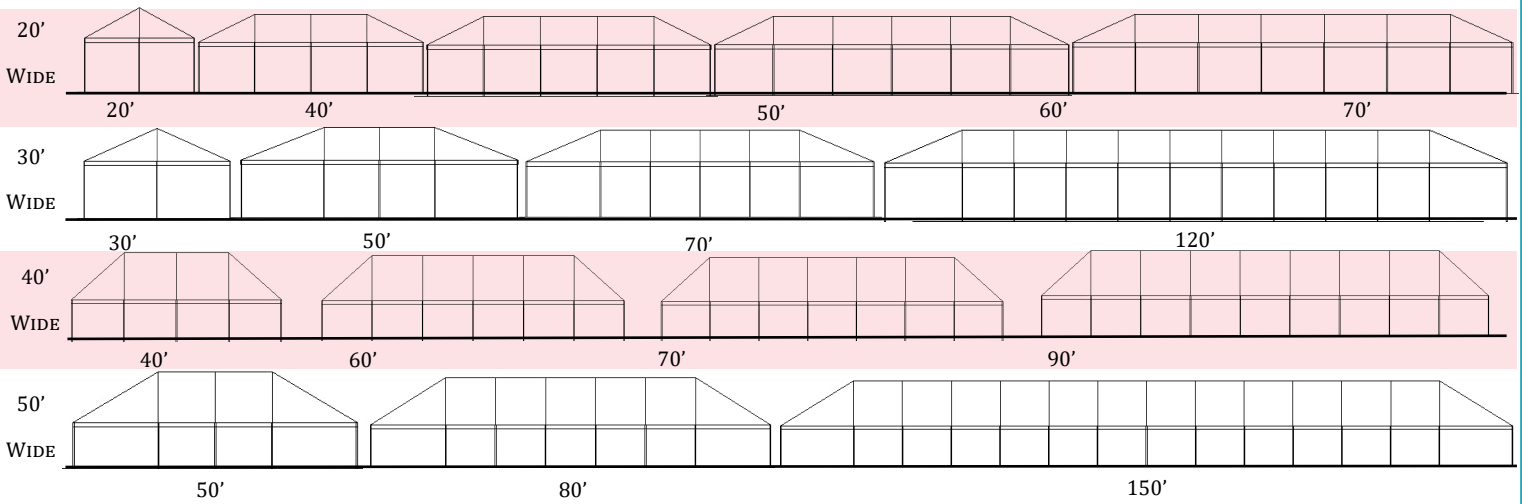

STRUCTURE



SAFETY COMPLIANCE: ALL OUR TENTS MEET STRINGENT BUILDING SAFETY REQUIREMENTS, ENSURING PEACE OF MIND FOR BOTH ORGANIZERS & ATTENDEES.

UNIQUE FRAMEWORK: FEATURES A UNIQUE TRACKING SYSTEM THAT MAKES THEM WATERTIGHT, KEEPING YOUR EVENT DRY & COMFORTABLE, RAIN OR SHINE. ALLOWS FOR EFFICIENT AIR CONDITIONING, ENSURING A PLEASANT ATMOSPHERE INSIDE.

CLIMATE CONTROL: HEAVY-DUTY BLOCK OUT VINYL HELPS MAINTAIN A COMFORTABLE ENVIRONMENT BY KEEPING IN THE AIR CONDITIONING DURING HOT SUMMER DAYS AND RETAINING HEAT IN THE WINTER.

NO INSIDE POLES: OUR STRUCTURE TENTS ARE DESIGNED WITH A CLEAR AND OPEN INTERIOR, ELIMINATING THE NEED FOR INSIDE POLES. THIS PROVIDES FULL ACCESS TO THE EVENT SPACE, MAKING IT IDEAL FOR VARIOUS LAYOUTS AND SETUPS.

SIZE AND CONFIGURATION VARIETY: WE OFFER A RANGE OF SIZES AND CONFIGURATIONS TO ACCOMMODATE YOUR SPECIFIC NEEDS. OUR STRUCTURE TENTS ARE AVAILABLE IN WIDTHS OF 18M (60'), 20M (65'), 25M (82'), AND 30M (98').

COLOR OPTIONS: CHOOSE BETWEEN WHITE OR CLEAR VINYL FOR YOUR STRUCTURE TENT, ALLOWING YOU TO CREATE THE DESIRED AMBIANCE AND LIGHTING EFFECTS.

SECURE INSTALLATION: OUR TENTS CAN BE SECURELY INSTALLED ON GRASS USING STAKES OR ON CONCRETE WITH CONCRETE WEIGHT BALLAST, ENSURING STABILITY REGARDLESS OF THE VENUE.

MOST POPULAR TENT SIZES:

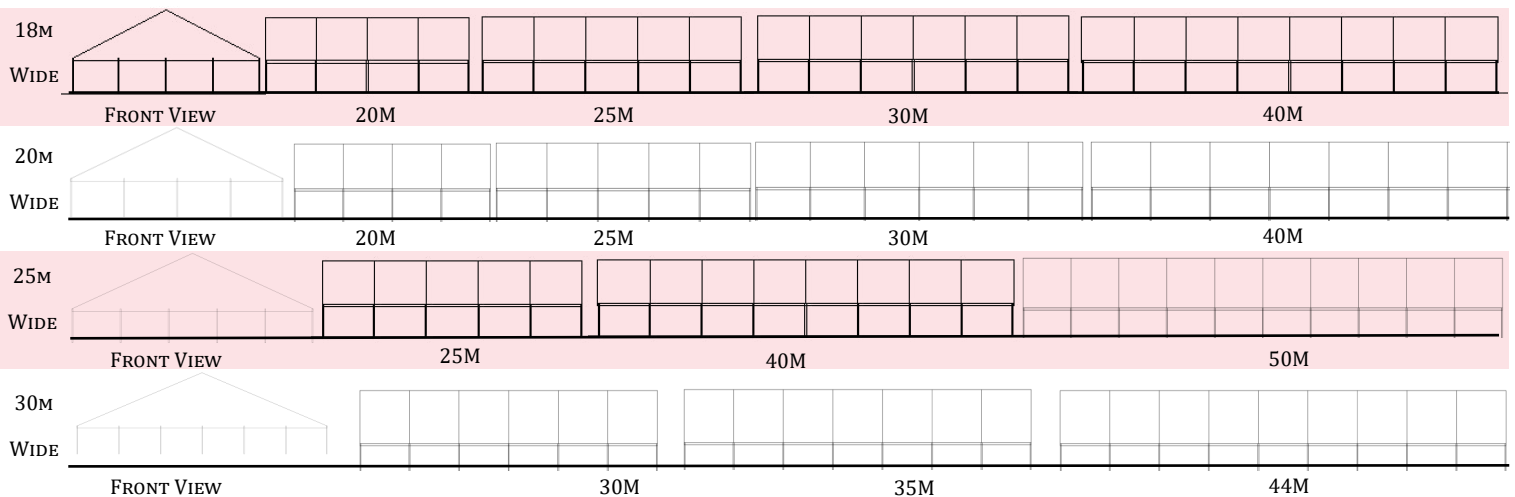

PRICE, SELECTION, AND AVAILABILITY ARE SUBJECT TO CHANGE. PLEASE VISIT PARTYLINERENTALS.COM FOR CURRENT SELECTION.

DRAMATIC PEAKS: DRAMATIC PEAKS, CAPTIVATING LOOKS THAT WILL IMPRESS YOUR GUESTS.

CLIMATE CONTROL: HEAVY-DUTY BLOCK OUT VINYL, GREAT AT KEEPING COOL IN THE SUMMER & WARMTH IN THE WINTER, ENSURING YEAR-ROUND COMFORT.

INNOVATIVE ENGINEERING: DESIGN DERIVES ALL ITS STRENGTH FROM POLES & VINYL TOPS, RESULTING IN A STRUCTURALLY SOUND & VISUALLY STUNNING TENT.

SPACE REQUIREMENTS: KEEP IN MIND THESE TENTS REQUIRE AN ADDITIONAL 10' DIAMETER FOR STAKES, MAKING THEM AN GREAT CHOICE FOR GRASSY AREAS.

VARIETY OF SIZES: RANGE OF SIZES & CONFIGURATIONS FOR LARGE EVENTS, STARTS FROM 40' & GOES UP TO 80' WIDE

CUSTOM INSTALLATIONS: INSTALLATION OPTIONS ARE AVAILABLE TO TAILOR TO YOUR UNIQUE EVENT REQUIREMENTS.

COLOR OPTION: WHITE VINYL, OFFERING A CLEAN AND ELEGANT LOOK.

SECURE INSTALLATION: SAFELY SECURED ON GRASS WITH STAKES, OR ON CONCRETE, WITH PERMISSION TO USE STAKES, ENSURING A STABLE & RELIABLE SETUP FOR YOUR EVENT.

MOST POPULAR TENT SIZES:

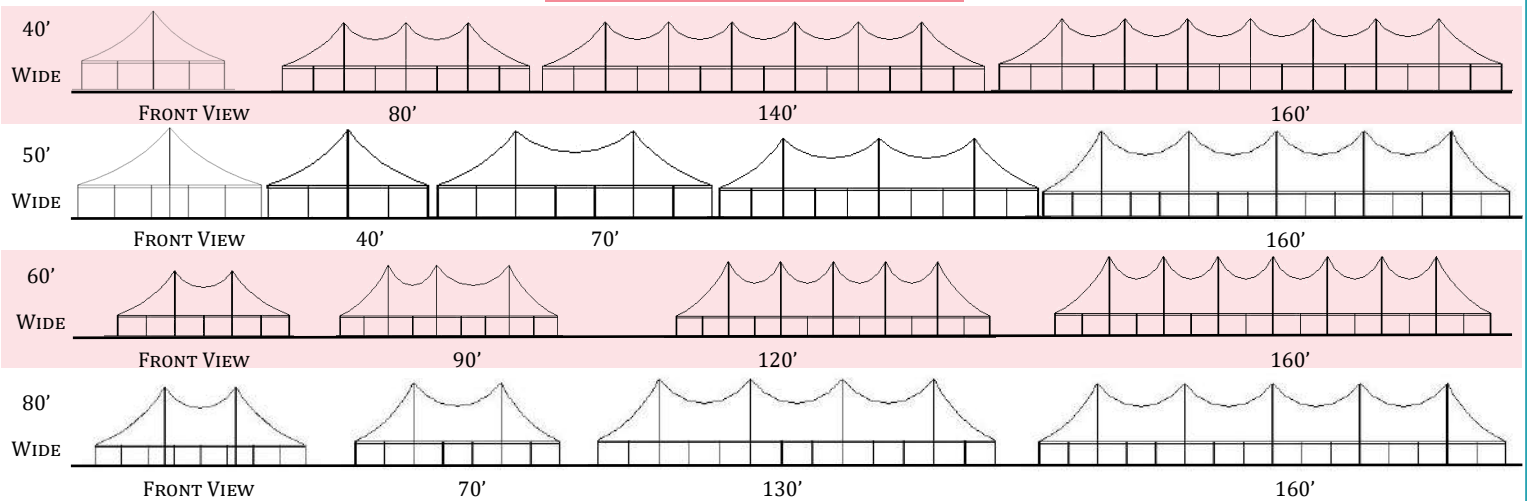

UNIQUE DESIGN: OUR SAILCLOTH TENTS FEATURE OCTAGONAL ENDS AND A SAILCLOTH TOP, GIVING THEM A UNIQUE AND DISTINCTIVE LOOK. THE WOOD GRAIN TEXTURED CENTER AND SIDE POLES ADD A TOUCH OF NATURAL ELEGANCE. THE SAILCLOTH MATERIAL ALLOWS NATURAL LIGHT TO FILTER THROUGH DURING THE DAY, CREATING A WARM AND INVITING AMBIANCE. WHEN ILLUMINATED AT NIGHT, IT OFFERS A ONE-OF-A-KIND, ETHEREAL ATMOSPHERE THAT IS SIMPLY MAGICAL.

WATERPROOF TOPS: UNLIKE MANY OTHER SAILCLOTH-STYLE TENTS, OUR TOPS ARE FULLY WATERPROOF, ENSURING YOUR EVENT REMAINS DRY AND COMFORTABLE IN CASE OF UNEXPECTED WEATHER CONDITIONS.

GATHERING-CENTRIC SHAPE: THE UNUSUAL SHAPE OF OUR SAILCLOTH TENTS HELPS TO DRAW YOUR GUESTS TOWARD THE CENTER OF THE EVENT, PROMOTING INTERACTION AND A SENSE OF TOGETHERNESS.

VERSATILE CENTER POLE: THE CENTER POLE OF OUR SAILCLOTH TENTS CAN BE DECORATED OR USED TO ATTACH LIGHTING, ALLOWING YOU TO CUSTOMIZE THE SPACE TO YOUR LIKING.

SIZE VARIETY: WE OFFER AN ELITE SELECTION OF SIZES, RANGING FROM 32' TO 44' WIDE, SO YOU CAN CHOOSE THE PERFECT DIMENSIONS FOR YOUR EVENT.

OFF WHITE SAILCLOTH: OUR SAILCLOTH TENTS ARE AVAILABLE EXCLUSIVELY IN OFF-WHITE SAILCLOTH FABRIC, PROVIDING A CLASSIC AND TIMELESS LOOK THAT COMPLEMENTS A VARIETY OF EVENT THEMES.

INSTALLATION REQUIREMENTS: PLEASE NOTE THAT SAILCLOTH TENTS CAN ONLY BE SECURELY INSTALLED ON GRASS USING STAKES.

MOST POPULAR TENT SIZES:

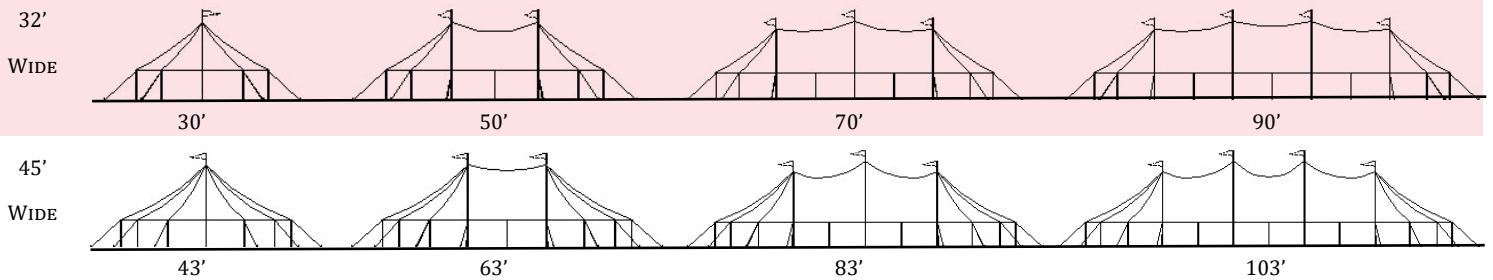



ENTRANCE ENHANCEMENT: ELEVATE YOUR EVENT'S ENTRANCE WITH MARQUEE TENTS, CREATING A MEMORABLE FIRST IMPRESSION. GREAT FOR AN ENTRANCE AND HALLWAY TENTS.

SEAMLESS CONNECTIONS: USE THEM TO CONNECT TENTS TO BUILDINGS, LINK MULTIPLE TENTS TOGETHER, OR ESTABLISH COVERED WALKWAYS, ENSURING A COHESIVE EVENT SPACE.

SPACE MAXIMIZATION: MARQUEE TENTS ARE PERFECT FOR SMALLER AREAS LIKE DECKS AND PATIOS, OPTIMIZING YOUR EVENT SPACE UTILIZATION.

AVAILABLE SIZES: CHOOSE FROM 6' AND 9' WIDE MARQUEE TENTS, AVAILABLE IN CONVENIENT 10' SECTIONS. CUSTOM LENGTHS CAN ALSO BE ACCOMMODATED TO MEET YOUR SPECIFIC NEEDS.

CLEAN AESTHETIC: THESE TENTS ARE AVAILABLE IN WHITE VINYL, OFFERING A CLEAN AND ELEGANT LOOK THAT COMPLEMENTS ANY EVENT THEME.

SECURE INSTALLATION: WHETHER ON GRASS OR CONCRETE, MARQUEE TENTS CAN BE EASILY SECURED USING STAKES OR CONCRETE WEIGHT BALLASTS, PROVIDING STABILITY AND SAFETY FOR YOUR EVENT.

MOST POPULAR TENT SIZES:

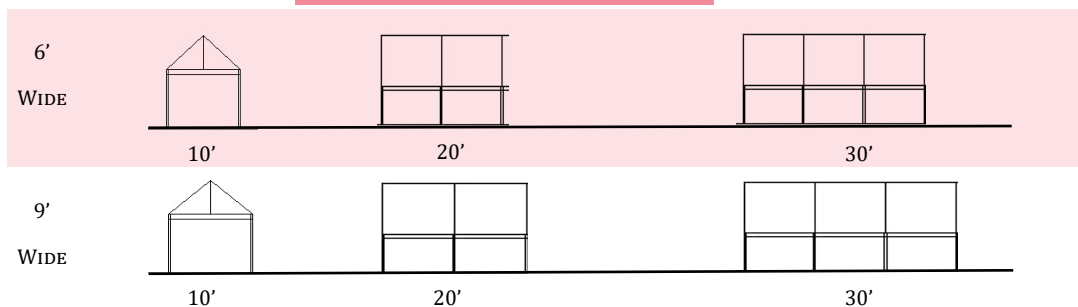

EXPLORE OUR DESIGN SHOWROOM CENTER AND DISCOVER THE PERFECT SETTING FOR YOUR DREAM EVENT. EXPERIENCE OUR SHOWCASED TENTS THAT AWAIT YOUR CREATIVE TOUCH. VISIT US AT **1 NEPPERHAN AVENUE, ELMSFORD, NY 10523**. WE LOOK FORWARD TO WELCOMING YOU SOON!





PAVILION TENT

USED OFTEN AS A TEMPORARY AWNING

- 12' x 15' FIESTA #0739
- 12' x 22.5' FIESTA #0740
- 20' x 20' NAVI #3270
- 20' x 30' NAVI #3271

WE OFFER CUSTOM SIZES! CALL TODAY!

DO IT YOURSELF POPUP TENT

10' x 10' #0718

COMES PACKED IN A 16" x 16" x 62" CARRYING CASE

HEAVY DUTY STYLE POPUP

FOR INSTALLATION ON GRASS WITH STAKES

WEIGHTS AVAILABLE



BARBEQUE COOKTOP TENT

#1203

6'w x 9.5'h x 10'l

ALUMINUM TOP

MEETS ALL FIRE DEPARTMENT & BOARD OF HEALTH REGULATIONS



20 Guest Party Package
16'x16' Tent
#7950

- 20X
- 3X
- 1X
- 1X



30 Guest Party Package
20'x20' Tent
#7953

- 30X
- 3X
- 1X
- 1X



50 Guest Party Package
20'x30' Tent
#7951

- 50X
- 5X
- 1X
- 2X



70 Guest Party Package
30'x30' Tent
#7954

- 70X
- 7X
- 2X
- 2X



100 Guest Party Package
30'x40' Tent
#7952

- 100X
- 10X
- 2X
- 3X





TENT UPGRADES

DON'T CONSIDER RENTING A TENT SOLELY AS A PRECAUTION AGAINST RAIN, JUST AS YOU WOULDN'T CONSTRUCT AN ARK FOR THE SAME REASON. REGARDLESS OF THE WEATHER, THE TENT SERVES AS THE CENTERPIECE FOR YOUR GATHERING. IT EFFECTIVELY CHANNELS THE ENERGY OF THE EVENT, PREVENTING GUESTS FROM DISPERSING AND WANDERING AIMLESSLY.



SOLID SIDEWALL

WHITE BLACKOUT VINYL OFFERS COMPLETE PRIVACY



CLEAR SIDEWALL

A GREAT SOURCE OF NATURAL LIGHT



CATHEDRAL WINDOW SIDEWALL

OUR MOST POPULAR OPTION

TENT SIDEWALLS & DOORS

SCREEN SIDES ALSO AVAILABLE



SINGLE SERVICE DOOR

#1249



DOUBLE SERVICE DOOR

#1247



DOUBLE STRUCTURE GLASS DOOR

*ONLY FOR STRUCTURE TENTS

#6010



SINGLE FRENCH DOOR

3'w x 85"H

HELPS WITH CLIMATE CONTROL & SECURITY

#1251



#1250 DOUBLE FRENCH DOOR

6'w

HELPS WITH CLIMATE CONTROL & SECURITY

** 2 DOOR KIT SHOWN



RAIN GUTTER

6' TO 60' LONG

KEEP YOUR GUESTS DRY AS THEY PASS THROUGH DOORWAYS AND TENTS

#1240



TENT LINERS | COVERS | WEIGHT



WHITE TENT LINER

ELEGANT FINISH FOR INSIDE YOUR TENT



TENT LEG SKIRTS

A GREAT WAY TO HIDE THE TENT LEGS
AVAILABLE FOR ALL TYPES OF TENTS



CENTURY CENTER POLE COVERS

COVERS THE POLES WITH A CLEAN
WHITE FABRIC



PIPE AND DRAPE

ELEGANT DESIGN FOR OUTSIDE YOUR TENT



VELON FABRIC FRAMEWORK WRAP

HIDE THE TENT HARDWARE WITH THIS MATTE FABRIC



TENT BALLAST STACKS

250 LBS #1214

500 LBS #6100

MEGA TENT BALLAST

2000LBS #1225

3000LBS #1236

4000LBS #1228

GET INSPIRED WITH CUSTOM UPGRADES

NAVI/FIESTA WHITE TENT LINER
TWINKLE LIGHTS | UPLIGHTS
CHIAVARI GOLD CHAIRS
60" ROUND TABLE WITH WHITE LINENS
CHANDELIERS



NAVI CLEAR TOP TENT
TENT LEG SKIRTS
RUSTIC FARM COLLECTION
TABLE RUNNERS
CUSTOM FLOORING



CENTURY POLE TENT W/ CLEAR SIDEWALLS
DOUBLE FRENCH DOORS
20 TON AC UNITS WITH DUCTS AND POWER



CENTURY TENT W/ CLEAR SIDEWALLS
CENTURY POLE COVERS
STRING LIGHTING
RUSTIC CROSSBACK CHAIR
WHITE LINENS
60" ROUND TABLES | 30" ROUND COCKTAIL TABLES



FIRE AND SAFETY FAQs

DO I NEED TO CONSIDER FIRE SAFETY WHEN RENTING A TENT FOR AN EVENT? YES, FIRE SAFETY IS ESSENTIAL WHEN RENTING A TENT.

HOW CAN I MINIMIZE FIRE RISKS WHEN USING A RENTED TENT? KEEP FLAMMABLE MATERIALS AWAY FROM HEAT SOURCES.

SHOULD I HAVE FIRE EXTINGUISHERS ON HAND WHEN RENTING A TENT? YES, IT'S HIGHLY RECOMMENDED TO HAVE FIRE EXTINGUISHERS ON-SITE. THE NUMBER AND TYPE OF FIRE EXTINGUISHERS NEEDED WILL DEPEND ON THE SIZE OF THE TENT AND THE SPECIFIC EVENT, BUT HAVING AT LEAST ONE READILY ACCESSIBLE IS A GOOD RULE OF THUMB.

CAN I USE PROPANE OR OTHER GAS-POWERED EQUIPMENT INSIDE THE TENT? PROPANE AND GAS-POWERED EQUIPMENT CAN BE USED INSIDE A TENT, BUT IT MUST BE DONE WITH PROPER VENTILATION AND SAFETY PRECAUTIONS. ENSURE GAS LINES AND EQUIPMENT ARE MAINTAINED AND LEAK-FREE.

ARE THERE RESTRICTIONS ON USING ELECTRICAL EQUIPMENT INSIDE THE TENT? ELECTRICAL EQUIPMENT MUST BE USED ACCORDING TO LOCAL CODES AND REGULATIONS AND ENSURE PERMITS ARE TAKEN CARE OF. THIS OFTEN INVOLVES HAVING A CERTIFIED ELECTRICIAN SET UP AND INSPECT THE ELECTRICAL SYSTEMS AND OR A PERMIT REQUIREMENT!

WHAT SHOULD I DO IN CASE OF A FIRE EMERGENCY INSIDE THE TENT?

1. FIRST, ENSURE THE SAFETY OF ALL ATTENDEES.
2. CALL EMERGENCY SERVICES IMMEDIATELY.
3. USE A FIRE EXTINGUISHER IF IT'S SAFE TO DO SO.
4. EVACUATE THE TENT IF THE FIRE CANNOT BE QUICKLY CONTROLLED.

DO I NEED A PERMIT(S) FOR SETTING UP A TENT FOR MY EVENT? THE NEED FOR A PERMIT CAN VARY BY LOCATION AND THE SIZE OF THE TENT. CHECK WITH YOUR LOCAL FIRE DEPARTMENT, BUILDING DEPARTMENT OR RELEVANT AUTHORITIES TO DETERMINE IF A PERMIT(S) IS REQUIRED. MULTIPLE TYPES OF PERMIT(S) MAY BE REQUIRED DEPENDING ON THE EVENT NEEDS AND MUNICIPALITIES. ONE OF OUR SALES REPRESENTATIVES WILL PROVIDE THE TENT PERMIT, FLAME CERTIFICATE, INSURANCE AND ANY OTHER REQUIRED DOCUMENTATION NEEDED FOR THE INSPECTORS.

IS IT NECESSARY TO HAVE EMERGENCY EXITS IN THE TENT FOR FIRE SAFETY? DEPENDING ON THE TENT'S SIZE AND OCCUPANCY, EMERGENCY EXITS MAY BE REQUIRED TO ENSURE THE SAFETY OF ATTENDEES. CONSULT LOCAL REGULATIONS TO DETERMINE THE SPECIFIC REQUIREMENTS.

SHOULD I HAVE A FIRE SAFETY PLAN IN PLACE FOR MY EVENT? YES, HAVING A FIRE SAFETY PLAN IS CRUCIAL. THIS PLAN SHOULD INCLUDE FIRE SAFETY MEASURES, EMERGENCY CONTACT INFORMATION, AND EVACUATION PROCEDURES. IT'S ALSO IMPORTANT TO BRIEF EVENT STAFF AND ATTENDEES ON THE PLAN.

FOR FURTHER INQUIRIES ABOUT FIRE AND SAFETY PERMITS, KINDLY REACH
OUT TO OUR DEDICATED SALES EXPERTS AT 914-592-1200.
THEY WILL BE PLEASED TO ASSIST YOU WITH YOUR REQUIREMENTS.



#2040 **FIRE EXTINGUISHER**
20 # | ABC



#2039 **K FIRE EXTINGUISHER**
6 LITERS



#2066 **SAFETY COMPLIANCE KIT**

KITS INCLUDES:

- LIGHTED EMERGENCY EXIT SIGN
- FIRE EXTINGUISHER W/ SIGN
- "NO SMOKING" SIGNS



#0553 **SMOKE DETECTOR**
BATTERY POWERED



#2062 **EXIT SIGN**
PLASTIC



#2060 **NO SMOKING SIGN**



#2069 **CARBON MONOXIDE DETECTOR**



#0557 **EMERGENCY EXIT SIGN**
LIGHT POWERED | 110 V



#2060 **CAPACITY SIGN**



#0556 **EMERGENCY LIGHTING**
LIGHT POWERED | 110 V



#2427 **MESSAGE BOARD**
SOLAR POWERED
126" X 76" FULL MATRIX



#2110 **LIGHT TOWER**
4K WATT DIESEL
0.47GPH | 30 GALLON
64 HR. RUN CAP.

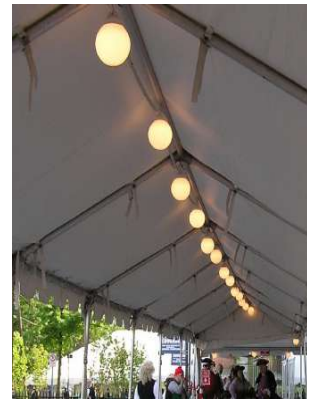

TENT LIGHTING

OUR LIGHTING RENTALS COVER ALL OF THE EVENT LIGHTING ESSENTIALS.

WE CARRY A RANGE OF OPTIONS FOR VENUE ACCENT LIGHTING, STAGE LIGHTING, TENT LIGHTING, OR DANCE FLOOR LIGHTING.

BROWSE OUR SELECTION OF WIRELESS UPLIGHTS, WASHES, SPOTS, FX-LIGHTING AND SO MUCH MORE!

COME AND VISIT OUR DESIGN CENTER SHOWROOM LOCATED AT **1 NEPPERHAN AVENUE IN ELMSFORD NY**





#0546 PAR 38 UP LIGHT

125 WATTS | UP TO 12 LIGHTS ON A 20 AMP CIRCUIT
 PERFECT FOR LIGHTING CEILINGS,
 WALLS & DANCE FLOORS



CUSTOM COLORS ARE AVAILABLE



#0537 LED PAR UP LIGHT RGBL

110 V | PRESET TO COLOR
 PERFECT FOR LIGHTING CEILINGS,
 WALLS & DANCE FLOORS



#3660 LED WASH UP LIGHT

WILL RUN BETWEEN 7-22 HOURS ON A FULL CHARGE
 PERFECT ACCENT LIGHTING FOR WALLS, PILLARS & DRAPES



#0543 PIN SPOTS

GREAT FOR LIGHTING CENTERPIECES
 WILL REQUIRE ADDITIONAL INSTALLATION CHARGES



#0539 MIRAGE LED UP LIGHT

BATTERY OPERATED | 6 LIGHT KIT | WIRELESS



#0559 **GOBO LIGHTING**

CHOOSE FROM 8 DIFFERENT DESIGNS:

- SNOWFLAKE
- STARS
- MUSIC NOTES
- DANCING COUPLE
- HEARTS
- CONGRATULATIONS
- HAPPY BIRTHDAY
- HAPPY HOLIDAYS



VISIT OUR LIGHTING SELECTION IN OUR DESIGN SHOWROOM.
 SEE FOR YOURSELF!
 1 NEPPERHAN AVENUE, ELMSFORD NY 10523

#3650 **ELLIPSOIDAL SOURCE FOUR LIGHTS**

GREAT FOR GOBOS, PATTERN WASHES OR CRISP SPOT LIGHTING
 CAN BE TINTED
 FEATURES A 19° FIELD ANGLE.

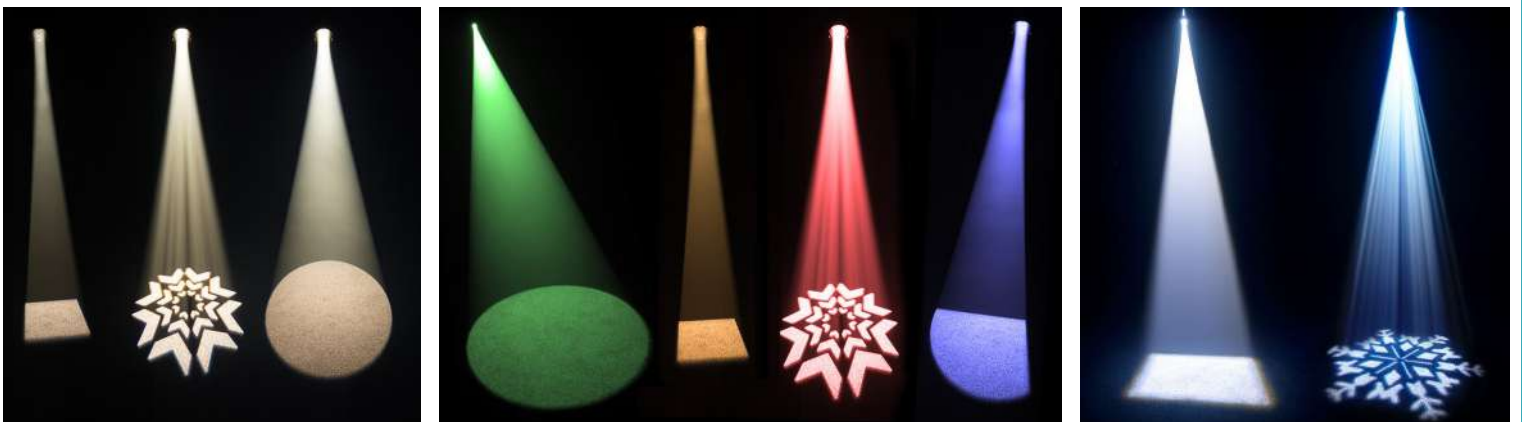



LED MINI LIGHTS

- #0662 50' x 100 COOL WHITE 6" SPACING
- #0663 23' x 50 COOL WHITE 6" SPACING
- #0561 MINI WHITE LED LIGHT—STRING

PATIO LIGHTS

- WHITE CORD "WARM LIGHT" 24 PER 54' #0562
- BLACK CORD "WARM LIGHT" 12 PER 24' #0672



#0555 **15 LIGHT WHITE CHANDELIER**

15 LIGHTS



#0541 **2-TIERED RING CHANDELIER**

20 LIGHTS





GLOBE LIGHTING

CLEAR #0560

FROSTED #0558

40 FOOT LONG STRING LIGHTS WITH 8-60 WATT BULBS
CAN BE PLUGGED END TO END SOFT
WARM GLOW SHATTER-RESISTANT BULBS



#0568 Low-Bay LED

LOW POWER USAGE. HIGH LUMEN OUTPUT
THE MOST LIGHT FOR YOUR MONEY



#0567 High-Bay LED

GREAT FOR COMMERCIAL APPLICATIONS

LOW BAY VS. HIGH BAY

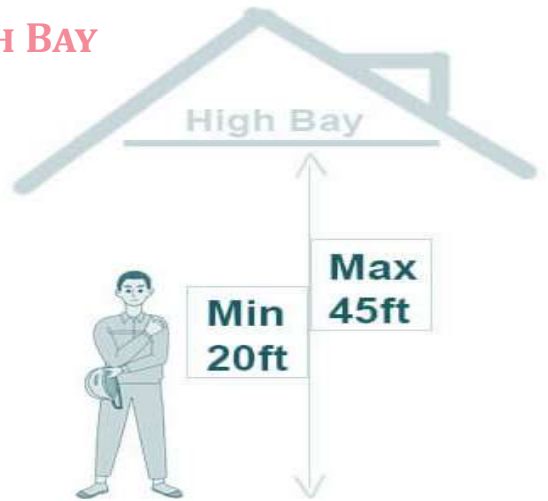
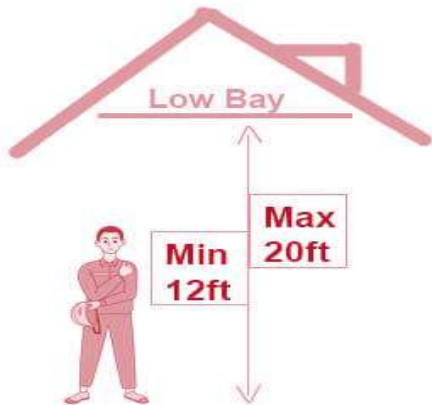



#0532 **LIGHT STAND**

T-BAR



#0565 **FLOOD LIGHT ON STAND**

1000 WATTS | LED



#0535 **STREET LAMP**

95" HEIGHT

WATERPROOF & WEATHERPROOF
FOR INDOOR & OUTDOOR EVENTS

#0578 **WOBBLE LIGHT**

36" HEIGHT

LIGHTS A RADIUS OF 25 FEET
WATERPROOF & WEATHERPROOF
GREAT FOR LIGHTING WALKWAYS



LIGHT TOWER

#2110

GET LIGHT WHENEVER AND WHEREVER YOU NEED IT!

4K WATT DIESEL

6,000 WATT STANDBY OUTPUT

PRIME FUEL CONSUMPTION 0.47GPH

30 GALLON CAPACITY

64 HOUR RUN CAPACITY

360 LIGHT ROTATION

30' HIGH MAXIMUM EXTENSION



WE'LL DELIVER TO YOUR AREA. CALL (914) 592-1200 TO SCHEDULE A DELIVERY TODAY!



HOW TO PICK THE RIGHT FLOORING SYSTEM THAT WORKS BEST FOR YOUR EVENT

THE RIGHT RENTAL FLOOR SYSTEM ENHANCES THE STYLE, COMFORT, & SAFETY OF YOUR EVENT. FLOORING ADDS A TOUCH OF CLASS & HELPS AVOID LIABILITY ISSUES CAUSED BY SLIPS, TRIPS, & FALLS. THE BEST RENTAL FLOORING OR GROUND COVERING FOR ANY EVENT DEPENDS ON **TWO** MAIN FACTORS:

1. WHETHER THE EVENT TAKES PLACE INDOORS OR OUTDOORS, AND THE UNDERLYING SURFACE.
2. OTHER CONSIDERATIONS INCLUDE, DURABILITY, SAFETY, AND GUEST COMFORT.

CERTAIN TYPES OF RENTAL FLOORING CAN BE INSTALLED ON UNEVEN SURFACES SUCH AS GRASS OR SAND. CHOOSING A RELATIVELY FLAT SITE WILL GIVE YOU A GREATER NUMBER OF FLOORING AND GROUND COVER STYLES TO CHOOSE FROM. FOR OUTDOOR EVENTS WHERE WET WEATHER IS A POSSIBILITY, THE RIGHT GROUND COVER CAN PREVENT YOUR SITE FROM TURNING INTO A MUDDY MESS. EVEN IN AREAS WHERE PRECIPITATION ISN'T A CONCERN, IT'S A GOOD IDEA TO CHOOSE FLOORING THAT IS SOMEWHAT SPILL AND SLIP-RESISTANT.

DEFINE THE PRIMARY USE OF YOUR FLOOR:

DANCE FLOOR: GRADUATIONS, ANNIVERSARY PARTIES, WEDDINGS, CORPORATE EVENTS, BACKYARD PARTIES

ASTRO TURF FLOORING: WEDDINGS, BACKYARD PARTY, SPORTING EVENTS, CONSTRUCTION SITES, PRODUCTIONS

BARN FLOORING: WEDDINGS, DANCE FLOORS, FORMAL EVENTS, COUNTRY FAIRS, SEASONAL CELEBRATIONS

TENT FLOORING: WEDDINGS, CORPORATE EVENTS, TRADE SHOWS, OUTDOOR PARTIES, FESTIVALS, SPORTING EVENTS, EXHIBITIONS, CONCERNS AND PERFORMANCES, OUTDOOR FASHION SHOWS, GALAS AND FUNDRAISERS.

CUSTOM CARPET: CORPORATE EVENTS, WALKWAYS, WEDDINGS, TRADE SHOWS, EXHIBITIONS, GALAS AND FUNDRAISERS, FASHION SHOWS, RED CARPET EVENTS, PRODUCT LAUNCHES.

FLOORING: CAR SHOWS, CORPORATE EVENTS, LIVE MUSIC EVENTS, FESTIVALS, FASHION SHOWS, OUTDOOR EVENTS, TEMPORARY INSTALLATIONS

STAGING: MUSIC BANDS, OUTDOOR EVENTS, CORPORATE EVENTS, WEDDINGS, BANDS, FASHION SHOWS, CONCERTS, THEATER PRODUCTIONS, AWARD CEREMONIES, SCHOOL AND COLLEGE EVENTS.

DISCOVER DETAILS ABOUT OUR DANCE FLOORS, TENT FLOORING,
CARPET, STAGING, & BLEACHERS ON OUR WEBSITE.
SCAN THE QR CODE TO ACCESS THE INFORMATION.





DANCE FLOOR | TENT FLOORING | CARPET | STAGING | BLEACHERS





#2400 **BARN FLOORING**
 REQUIRES 2' X 6' STRINGERS OR TO BE PUT ON ANOTHER SUB-FLOOR
 NO "EDGING" AVAILABLE AT THIS TIME

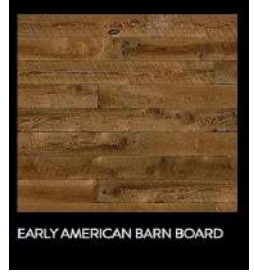

#0821 **CHERRY**



#0802 **BLACK & WHITE**



#3190 **WHITE**



#0820 **BLACK**



#0804



#3193

CHOICE OF BLACK OR SILVER EDGES AVAILABLE

OUR DANCE FLOORS ARE DESIGNED TO CATER TO YOUR SPECIFIC NEEDS, WITH EACH SECTION MEASURING 4' X 4'. THIS MODULAR DESIGN ALLOWS FOR EASY ASSEMBLY AND CUSTOMIZATION BASED ON THE AVAILABLE SPACE OR NUMBER OF ATTENDEES. DANCE FLOORS CAN BE INSTALLED OUTDOORS ON A SOLID AND APPROPRIATE SURFACE, PROVIDING A VERSATILE SOLUTION FOR OUTDOOR EVENTS.

POPULAR SIZES LISTED BELOW; CUSTOM SIZES ALSO AVAILABLE

TO ESTIMATE THE SQUARE FOOTAGE FOR YOUR DANCE FLOOR—SIMPLY MULTIPLY THE GUEST COUNT BY 3!

 EXAMPLE: I HAVE 50 GUESTS. I NEED A 150SQ FT DANCE FLOOR.

8X8	8X12	8X16	8X20	8X24	8X28	8X30	8X36	8X40	8X44
12X12	12X16	12X20	12X24	12X28	12X32	12X36	12X40	12X44	12X48
16X16	16X20	16X24	16X28	16X32	16X36	16X40	16X44	16X48	16X52
20X20	20X24	20X28	20X32	20X36	20X40	20X44	20X48	20X52	20X56
24X24	24X28	24X32	24X36	24X40	24X44	24X48	24X52	24X56	24X60
28X28	28X32	28X36	28X40	28X44	28X48	28X52	28X56	28X60	28X64
32X32	32X36	32X40	32X44	32X48	32X52	32X56	32X60	32X64	32X68
36X36	36X40	36X44	36X48	36X52	36X56	36X60	36X64	36X68	36X72
40X40	40X44	40X48	40X52	40X56	40X60	40X64	40X68	40X72	40X76

ARE YOU STAGING A SHOW, CONCERT OR MARQUEE EVENT ON TURF THAT NEEDS TO BE PROTECTED?

#0801 **ULTRADECK**

1' X 2' X 1¼" H SIGNATURE SYSTEMS
 2.88 LBS. / SECTION | WEIGHT LOAD 138PSI
 20,000 PSF WITH SOLID SUBSURFACE
 USE ON BLACKTOP & OTHER SOLID SURFACES
 NOT RECOMMENDED FOR USE ON GRASS
 EXPANSIONS JOINTS AND TRIM AVAILABLE



#0825 **ARMOURDECK**

ARMOURDECK FLOORING IS OUR MOST HEAVY DUTY TEMPORARY FLOORING OPTION. THIS PREMIUM FLOOR TILE SYSTEM IS SPECIALLY DESIGNED TO HANDLE HEAVY TRAFFIC, PROVIDING STABILITY AND GROUND PROTECTION. ARMOURDECK CAN BE USED AS EVENT FLOORING FOR:

- WEDDINGS
- PRODUCTIONS
- STADIUM CONCERTS
- LARGE GRADUATIONS
- CONCERTS & FESTIVALS
- CORPORATE AND PRIVATE EVENTS
- TRADESHOW

SPECIFICATIONS	
SIZE	42" x 42" SURFACE AREA 45" x 45" OUTER DIMENSION INCLUDING TAB
WEIGHT	31 LBS.
MATERIAL	HIGH-DENSITY POLYETHYLENE (HDPE)





#0828 **DURA-TRAC**

DURA-TRAC IS A HEAVY-DUTY ENGINEERED TEMPORARY FLOORING SYSTEM THAT IS USED TO LAYDOWN ROADWAY FLOORING ON TURF, SOIL, SAND, GRAVEL, SNOW, TARMAC, AND CONCRETE.

DURA-TRAC PROVIDES A SOLID FOUNDATION FOR EVENTS AND INDUSTRIES OF ALL SIZES.

USED IN:

- CONCERTS
- FESTIVALS
- CEREMONIES
- WEDDINGS
- CORPORATE AND PRIVATE EVENTS
- TRADE SHOWS
- TENT EVENTS
- PRODUCTIONS

SPECIFICATIONS	
SIZE	4 FT W X 4 FT L X 2.75 IN. THINK (1.22M W X 2.4M L X 1.3 CM H)
WEIGHT	64 LBS.
MATERIAL	STRUCTURAL FOAM MOLDED WITH HIGH-DENSITY POLYETHYLENE (HDPE) THE BACK IS HOT-PLATED WELDED TO THE PANEL FOR AN IMPERMEABLE SEAL
WEIGHT LOAD	50,000 LBS. (BEARING GROUND) 1,000 LBS. (ELEVATED)

#0860 **DURA-DECK "ROADWAY MATS"**

DURA-DECK MATS ARE STRONG, DURABLE, LONG LASTING, EASY TO MAINTAIN AND ENGINEERED TO BE USED FOR WIDE RANGE OF APPLICATIONS, INCLUDING:

- TEMPORARY OUTDOOR EVENT FLOORING
- PLASTIC PLYWOOD
- GROUND PROTECTION
- TEMPORARY ROADWAYS
- PEDESTRIAN WALKWAYS
- WORK PLATFORMS
- STAGING AREAS FOR CONSTRUCTION AND LANDSCAPING



SPECIFICATIONS	
SIZE	4 FT W X 8 FT L X 0.5 IN H (1.22M W X 2.4M L X 1.3 CM H)
WEIGHT	87 LBS. (40 KG)
MATERIAL	HIGH-DENSITY POLYETHYLENE (HDPE) WITH SPECIAL IMPACT MODIFIERS THAT INCORPORATE UV RESISTANCE AND ANTI-STATIC PROPERTIES
COLOR	BLACK
WEIGHT LOAD	200 PSI, DEPENDING ON SUBSURFACE CONDITIONS



#0135 **BIL-JAX 8100**

4' X 4' STEEL FRAME PAINTED PLYWOOD DECK—"OUTDOOR STAGE"
 FOR RAISED LEVELED STAGES, TENT FLOORS, TIERED STAGING
 GUARD RAIL AVAILABLE
 LOAD RATING 150 PSF
 ENGINEERED SPEC AVAILABLE—SHOULD BE COVERED

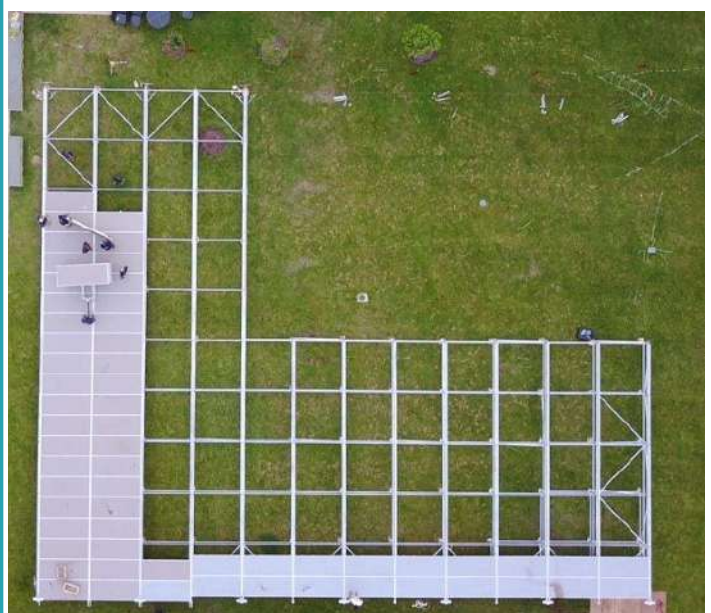
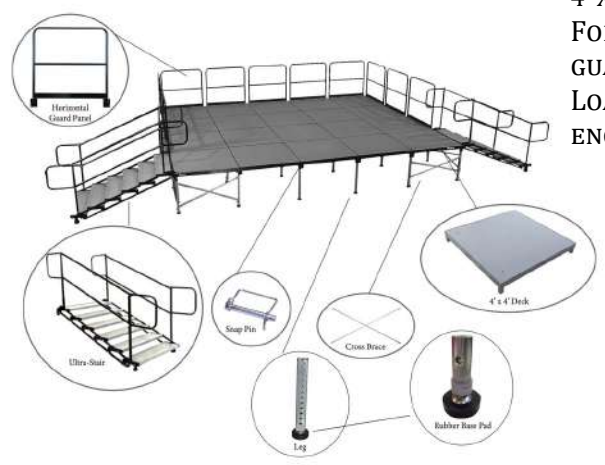

#7600 **BIL-JAX TF2100**

ENGINEERED FLOORING SYSTEM—TENT LOCKS INTO FLOOR SYSTEM—SIZES VARY
 UP TO 50' X 100' MAX (AT THIS TIME) FROM GROUND LEVEL TO 48" HIGH
 DECKING IS ALUMINUM FRAME WITH PAINTED PLYWOOD—SHOULD BE COVERED
 LOAD RATING 125# PSF—ENGINEERED SPECS AVAILABLE

IT IS THE PERFECT SOLUTION FOR:

- WEDDINGS
- RECEPTIONS
- FESTIVALS
- CORPORATE EVENTS
- PRODUCTIONS



CUSTOM FLOORING

UNCERTAIN WHETHER YOUR BACKYARD CAN ACCOMMODATE
A TENT, STAGE, OR DANCE FLOOR? NO PROBLEM!
WE ARE ABLE TO CONVERT 2000 SQ. FEET OF AN UN-LEVELLED BACKYARD AND
TURN IT INTO OVER 3500 SQ. FEET OF USEFUL EVENT SPACE.



The customer's In ground Pool at time of the site inspection



Wooden I Beams are secured to a layer of plywood for the highest level of stability over the pool area

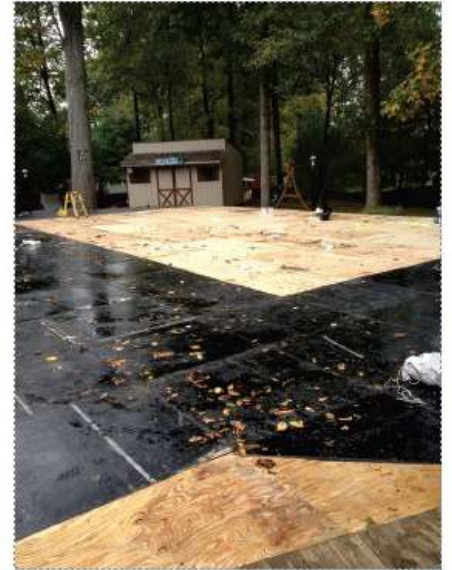

Bi-Jax staging setup and leveled to match up flush with the I beams



The customers custom Deck posed an interesting dilemma...



...But not for Party Line! We cut plywood and I Beams to meet the Deck and Bi-Jax evenly.



Everything leveled to perfection. Laying down the Carpet and putting on the finishing touches

ASTRO TURF FLOORING

BLACK | GREEN | TAN | WHITE
#0809 | #0810 | #0813 | #0812



MORE CUSTOM COLORS ARE AVAILABLE.
MUST BE LAID OVER SUBFLOORING

CUSTOM CARPETING

ALL COLORS ARE BROUGHT IN ON A PER ORDER BASIS MUST BE LAID OVER SUBFLOORING



MORE COLORS ARE AVAILABLE. CALL FOR DETAILS.

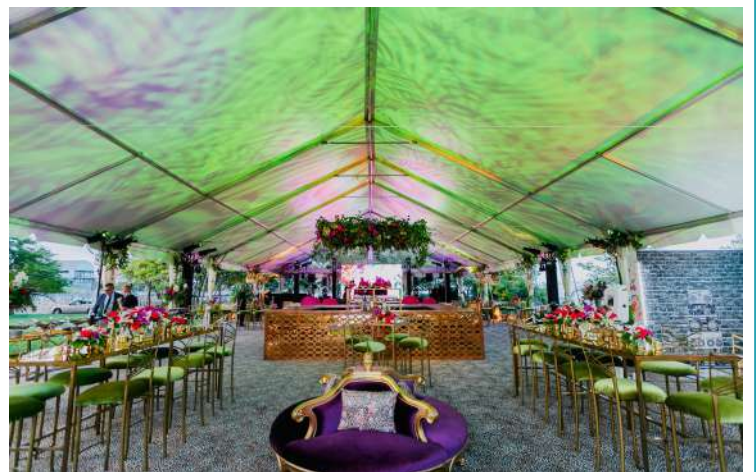

ELEVATE YOUR OUTDOOR STAGE EXPERIENCE

ARE YOU READY TO TAKE YOUR OUTDOOR STAGE TO THE NEXT LEVEL? WHETHER YOU'RE HOSTING AN OUTDOOR CONCERT, A THEATRICAL PERFORMANCE, A CORPORATE EVENT, OR ANY GATHERING THAT REQUIRES A DYNAMIC AND FLEXIBLE STAGE SETUP, OUR OUTDOOR STAGING SOLUTIONS HAVE GOT YOU COVERED. WE SPECIALIZE IN DESIGNING STAGES WITH MULTIPLE HEIGHTS, ENSURING THAT YOUR EVENT STANDS OUT FROM THE REST.



STAGE WITH BANDSHELL



LEVELED STAGE IN BACKYARD

KEY FEATURES:

MULTIPLE HEIGHTS: OUR STAGES CAN BE CUSTOMIZED TO VARIOUS HEIGHTS TO SUIT YOUR SPECIFIC NEEDS. FROM SMALL PLATFORMS TO GRAND, MULTI-LEVEL STRUCTURES, WE DESIGN STAGES THAT ELEVATE YOUR EVENT'S VISUAL APPEAL.

STAIR ACCESS: NO MATTER WHAT HEIGHT YOUR STAGE IS, WE HAVE STAIR SOLUTIONS THAT CAN ACCOMMODATE UP TO 80 INCHES HIGH. ENSURE SEAMLESS ACCESS FOR YOUR PERFORMERS AND CREW.

ADAPTABLE TO DECLINES AND INCLINES: OUR OUTDOOR STAGES ARE DESIGNED TO BE VERSATILE, EVEN IN CHALLENGING TERRAINS. WE CAN ACCOMMODATE SPACES WITH EXCESSIVE DECLINES OR INCLINES, ENSURING A STABLE AND SAFE PLATFORM.

SAFETY FIRST: FOR STAGES OVER 24 INCHES HIGH, WE OFFER GUARDRAILS THAT COMPLY WITH ENGINEERING SAFETY REQUIREMENTS. YOUR PERFORMERS AND AUDIENCE CAN ENJOY THE EVENT WITH PEACE OF MIND.

ADA COMPLIANT WHEELCHAIR RAMPS: WE UNDERSTAND THE IMPORTANCE OF INCLUSIVITY. THAT'S WHY WE OFFER ADA COMPLIANT WHEELCHAIR RAMPS, MAKING YOUR EVENT ACCESSIBLE TO EVERYONE.

HUNDRED DIFFERENT COMBINATIONS TO PLACE YOUR STAGE

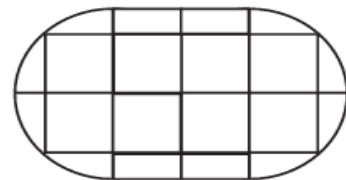
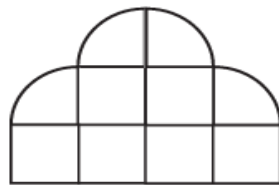
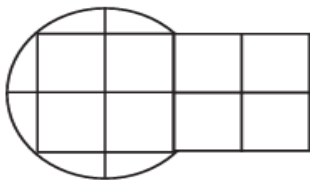
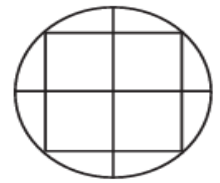
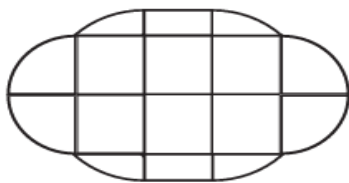

ELEVATE YOUR INDOOR STAGE EXPERIENCE

ARE YOU READY TO TAKE YOUR INDOOR STAGE TO THE NEXT LEVEL? THE AS2100 IS AN IDEAL CHOICE FOR ELEGANT INDOOR EVENTS LIKE WEDDINGS, FASHION SHOWS, AND SPEAKING ENGAGEMENTS. FINISHED WITH A SLEEK, MODERN DESIGN, OUR ALUMINUM EVENT STAGES CONTRIBUTE TO A CONTEMPORARY EVENT ENVIRONMENT, ENSURING A CLEAN AND CRISP LOOK FOR ANY OCCASION.

KEY FEATURES:

VERSATILE CONFIGURATIONS: OUR ALUMINUM STAGES ARE REMARKABLY VERSATILE, ALLOWING CONFIGURATIONS IN VARIOUS SHAPES AND SIZES TO MEET THE SPECIFIC REQUIREMENTS OF DIVERSE EVENTS.

AESTHETIC APPEAL: FINISHED WITH SLEEK, MODERN DESIGNS, OUR ALUMINUM EVENT STAGES CONTRIBUTE TO A CONTEMPORARY EVENT ENVIRONMENT, ENSURING A CLEAN AND CRISP LOOK FOR ANY OCCASION.

LIGHTWEIGHT EXCELLENCE: ALUMINUM, SIGNIFICANTLY LIGHTER THAN STEEL, ENSURES EASY TRANSPORTATION, ASSEMBLY, AND DISASSEMBLY – PERFECT FOR EVENTS REQUIRING FREQUENT SETUP AND TEAR-DOWN.

UNMATCHED PORTABILITY: THE INHERENT LIGHTNESS OF ALUMINUM STAGES MAKES THEM HIGHLY PORTABLE, IDEAL FOR EVENTS IN LOCATIONS WHERE HEAVY EQUIPMENT IS IMPRACTICAL OR SWIFT SETUP IS ESSENTIAL.

SAFETY FIRST: FOR STAGES OVER 24 INCHES HIGH, WE OFFER GUARDRAILS THAT COMPLY WITH ENGINEERING SAFETY REQUIREMENTS. YOUR PERFORMERS AND AUDIENCE CAN ENJOY THE EVENT WITH PEACE OF MIND.

ADA COMPLIANT WHEELCHAIR RAMPS: WE UNDERSTAND THE IMPORTANCE OF INCLUSIVITY. THAT'S WHY WE OFFER ADA COMPLIANT WHEELCHAIR RAMPS, MAKING YOUR EVENT ACCESSIBLE TO EVERYONE.

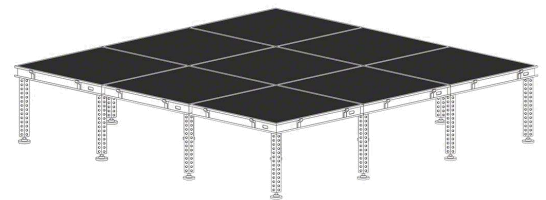

#4301 [BIL-JAX AS2100](#)

4' X 4' ALUMINUM FRAME—"INTERIOR STAGE"
CLEAN LOOK WITH RUBBER SKID FREE DECK
FOR RAISED STAGES, TIERED STAGING
GUARD RAIL AVAILABLE
LOAD RATING 175# PSF
ENGINEERED SPEC AVAILABLE

#4302 [BIL-JAX AS2100](#)

4' X 8' ALUMINUM FRAME—"INTERIOR STAGE"
CLEAN LOOK WITH RUBBER SKID FREE DECK
FOR RAISED STAGES, TIERED STAGING
GUARD RAIL AVAILABLE
LOAD RATING 175# PSF
ENGINEERED SPEC AVAILABLE





OUTDOOR AND INDOOR TIERED STAGING

OUTDOOR AND INDOOR TIERED STAGING IS VERSATILE AND CAN BE ADAPTED TO VARIOUS EVENTS WHERE ELEVATED PLATFORMS ARE NEEDED TO OPTIMIZE SIGHTLINES AND AUDIENCE EXPERIENCE. ALSO IT IS USED IN EVENTS WHERE THERE IS A NEED FOR ELEVATED AND TIERED PLATFORMS TO ENHANCE VISIBILITY FOR THE AUDIENCE INCLUDING:

- SPORTING EVENTS
- GRADUATION CEREMONIES
- AWARD CEREMONIES
- CONCERTS AND MUSIC FESTIVALS
- OUTDOOR THEATER PRODUCTIONS
- CORPORATE EVENTS AND PRESENTATIONS
- COMMUNITY EVENTS/GATHERINGS



STAGING ACCESSORIES



#6050 RAMP KIT
ADA COMPLIANT | ALUMINUM



#ST3 QUICK STEP
3 STEP SETUP | 15" - 21"
WITH HAND RAILS



#ST4 QUICK STEP
4 STEP SETUP | 16" - 28"
WITH HAND RAILS



#ST6 QUICK STEP
6 STEP SETUP | 24" - 48"
WITH HAND RAILS



#ST10 QUICK STEP
10 STEP SETUP | 40" - 80"
WITH HAND RAILS



#4110 **3 ROWS | 18 SEATS**
9' L X 2'6"H X 4'8"W



#0150 **4 ROWS | 40 SEATS**
15' L X 2'6"H X 8'W



#0149 **5 ROWS | 50 SEATS**
15' L X 3'H X 9'W
COMES WITH GUARD RAIL

#4120 **7 ROWS | 107 SEATS**
26'5"L C 9'6"H C 13'W
COMES WITH GUARD RAIL AND AISELS
TOWABLE



DID YOU KNOW WE CAN DELIVER TO
YOUR EVENT LOCATION?
CALL (914) 592-1200 FOR DETAILS AND
PRICING.





TABLES

GET READY TO TURN YOUR EVENT INTO A TABLE-TASTIC EXTRAVAGANZA WITH PARTY LINE RENTALS! PARTY LINE RENTALS HAS TABLES OF ALL SHAPES, SIZES, AND STYLES IT'S LIKE A TABLE LOVER'S DREAM COME TRUE! BUT WAIT, THERE'S MORE FUN IN STORE! OUR TEAM OF EVENT PROS IS HERE TO SPRINKLE SOME MAGIC ON YOUR PARTY PLANNING. THEY'LL NOT ONLY HOOK YOU UP WITH THE COOLEST TABLES BUT ALSO HELP YOU CREATE THE ULTIMATE TABLE SETUP. FROM ELEGANT PLACEMENTS TO MIND-BLOWING CONFIGURATIONS, WE'VE GOT YOUR EVENT SPACE COVERED!



<u>4' x 30"</u> #0107	SEATS ABOUT 4-6 GUESTS
<u>6' x 24"</u> #0871	SEATS ABOUT 6-8 GUESTS
<u>6' x 30"</u> #0101	SEATS ABOUT 6-8 GUESTS
<u>6' x 36"</u> #0874	SEATS ABOUT 6-8 GUESTS
<u>6' x 42"</u> #0623	SEATS ABOUT 6-8 GUESTS
<u>8' x 24"</u> #0872	SEATS ABOUT 8-10 GUESTS
<u>8' x 30"</u> #0100	SEATS ABOUT 8-10 GUESTS
<u>8' x 36"</u> #0875	SEATS ABOUT 8-10 GUESTS
<u>8' x 42"</u> #0624	SEATS ABOUT 8-10 GUESTS

BANQUET TABLE



CONFERENCE TABLE



6' x 18" #0105

8' x 18" #0878

42" LEG EXTENDERS #99L

TABLES RISERS #0125

6' x 12" w 12" h

CARD TABLE



30' x 30' | #0109

WORK TABLE W/ ADJUSTABLE LEGS

6' x 30" x (36" - 42") #0128

8' x 30" x (36" - 42") #0129



#0098 **TABLE CASTER WHEELS**
PERFECT FOR CAKE TABLES

PICNIC TABLE WITH BENCHES

#0627 | 8'L x 13"W x 19.5"H
SEATS 4 ADULTS



VISIT US ONLINE AT PARTYLINERENTALS.COM OR STOP BY OUR PHYSICAL LOCATION AT 1 NEPPERHAN AVENUE, ELMSFORD, NY. WE CAN'T WAIT TO CONNECT WITH YOU!



ROUND SEATING TABLE



STANDARD HEIGHT IS 30"

#0106 <u>42"</u>	SEATS ABOUT 5 GUESTS
#0111 <u>48"</u>	SEATS ABOUT 7 GUESTS *
#0108 <u>54"</u>	SEATS ABOUT 8 GUESTS *
#0112 <u>60"</u>	SEATS ABOUT 8-10 GUESTS *
#0115 <u>72"</u>	SEATS ABOUT 10-12 GUESTS

1/2 ROUND TABLE



60" #0121

72" #0619

PERFECT FOR SWEETHEART TABLES

SERPENTINE 1/4 ROUND



SMALL 5' x 30" #0120

LARGE 7' x 30" #0122

1/4 ROUND TABLE



30" WIDE TABLE

#0117

A GREAT WAY TO "ROUND OUT" A BUFFET TABLE

SERPENTINE RISER



#0123

TAKE YOUR SERPENTINE TABLE
TO THE NEXT LEVEL!



RISER CLAMPS

FOR INCREASED STABILITY
#125c



PLASTIC RECTANGULAR FOLDING TABLE

30" x 70" #0104
 30' x 96" #0868



PLASTIC ROUND FOLDING TABLE

#0865 48"
 #0866 60"

COCKTAIL "HIGH TOP" TABLES

<u>24" ROUND TABLE</u>	#0116
<u>30" ROUND TABLE</u>	#0113
<u>36" ROUND TABLE</u>	#0110

WE CARRY DIFFERENT SIZE LENGTH LEGS:

30-42" EXTENDABLE #0114
 13" COFFEE TABLE HEIGHT #0647



<u>Table Size</u>	<u>Tablecloth Size</u>			
	90 inch Round	108 inch Round	120 inch Round	132 inch Round
 <p>24" round top 42" H</p>	33" Drop	Drop	Puddle	Puddle
 <p>30" round top 42" H</p>	30" Drop	39" Drop	Puddle	Full Drape
 <p>36" round top 42" H</p>	27" Drop	36" Drop	Full Drape	Puddle

RUSTIC COLLECTION



#0626 FARM TABLE
8'L x 40"W x 30"H
CAN COMFORTABLE SEAT 10 GUESTS



#0628 FARM PUB TABLE
36"L x 36"W x 42"H



#4720 FARM SWEET HEART TABLE
40" x 5'



#0625 ROUND FARM TABLE
60"W x 30"H
CAN COMFORTABLE SEAT 10 GUESTS



#0627 FARM BENCH
8'L x 13"W x 19.5"H
SEATS 4 ADULTS



X20 CROSSBACK BAR STOOL
#0612



X20 CROSSBACK CHAIR
NATURAL WOOD #0613
RUSTIC WOOD #0617



#4990 WINE BARREL
23"W x 37"H



#4722 BARREL TOPPER
40" ROUND

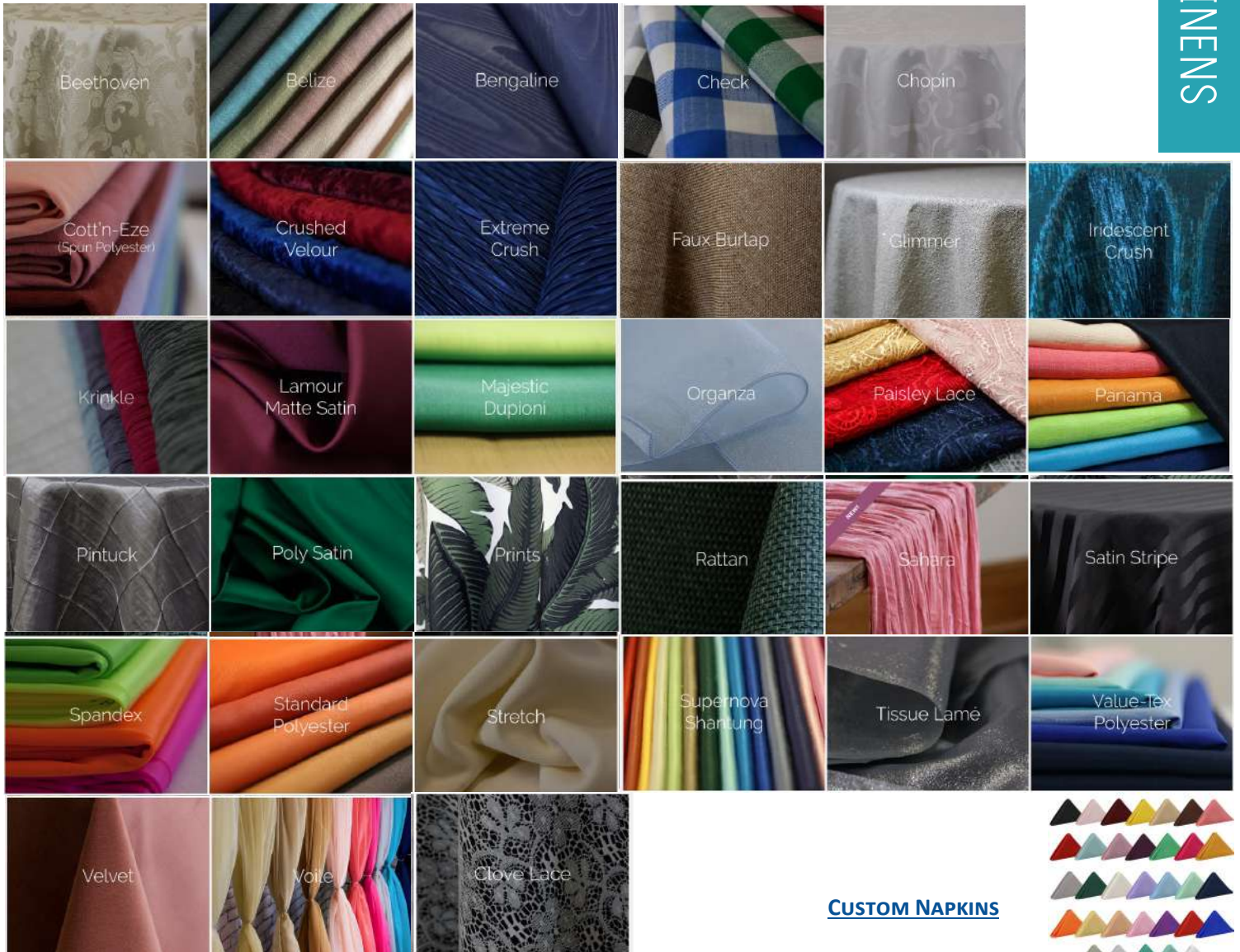

CUSTOM NAPKINS

COME LOOK TOUCH FEEL THE REAL THING IN OUR SHOW-ROOM. PICTURES DON'T DO JUSTICE TO OUR LINE OF LINENS
 1 NEPPERHAN AVENUE ELMSFORD NY 10523



CUSTOM CHAIR CUSHION COVERS

CUSTOM BAR STOOL COVERS

TABLE RUNNERS

CHAIR COVERS AND SASHES



HOW TO CHOOSE THE RIGHT SIZE LINEN

Round Table

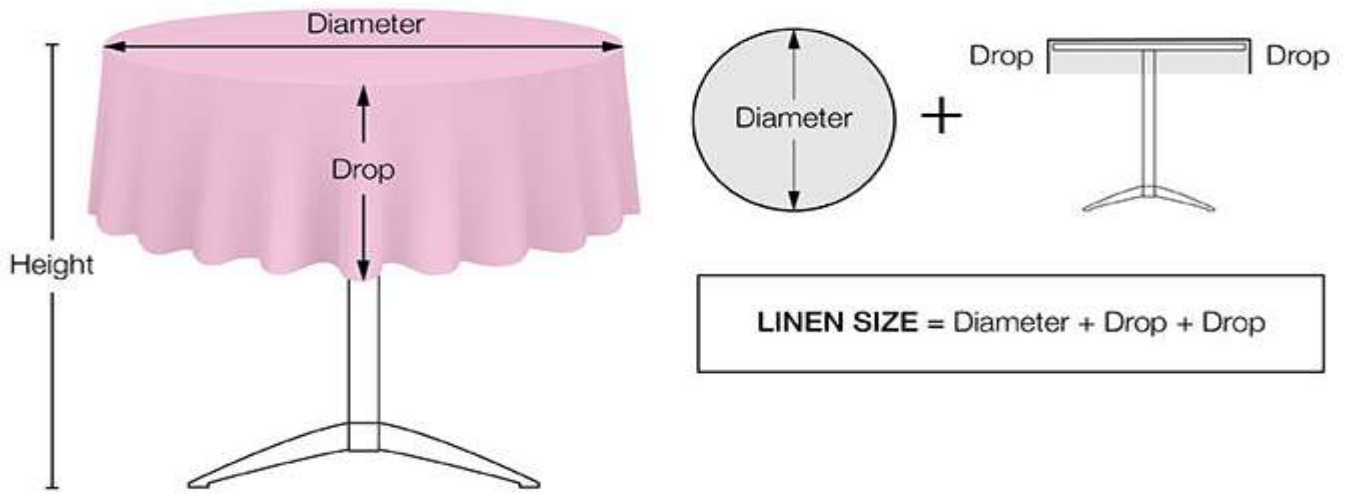

Rectangle or Square Table

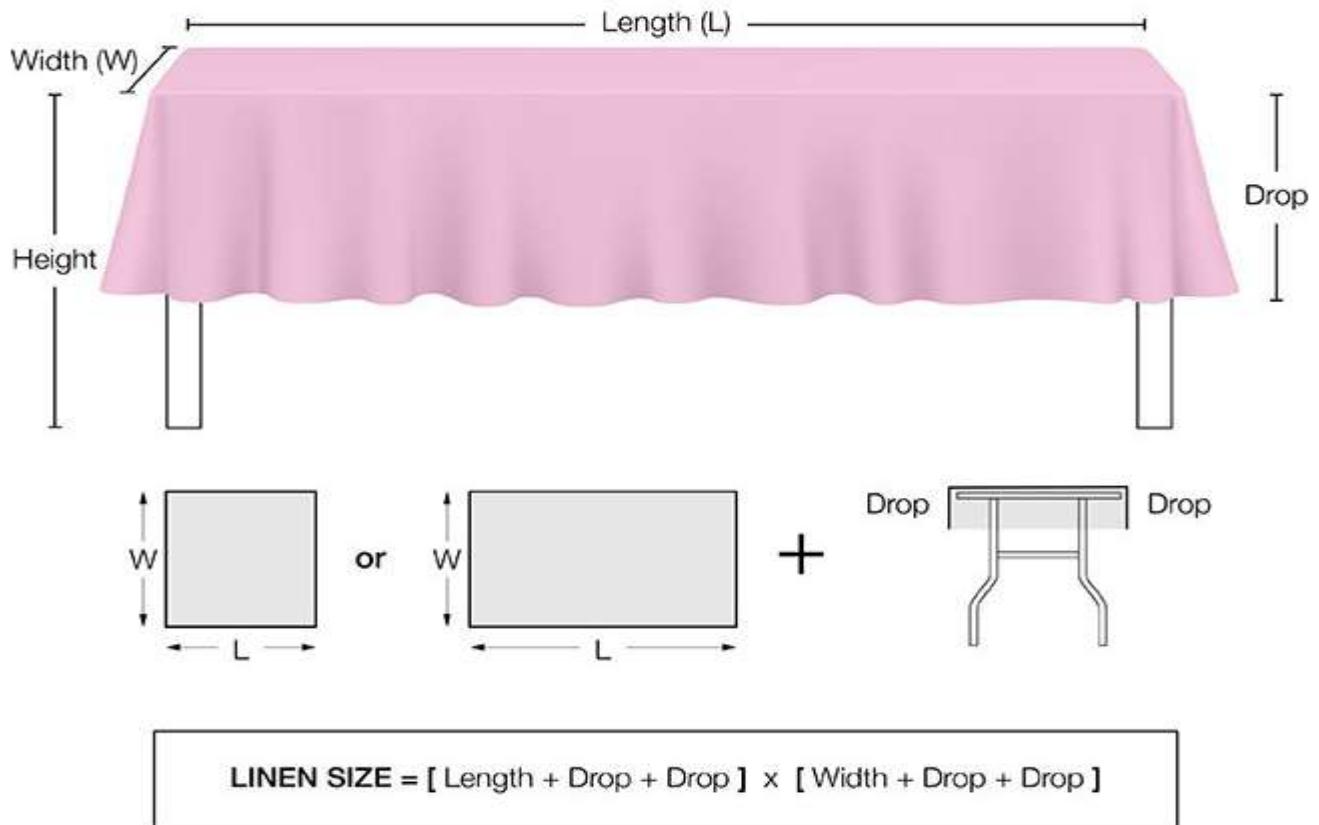

HOW TO CHOOSE THE RIGHT SIZE LINEN

Table Size		Tablecloth Size			
		90 inch Round	108 inch Round	120 inch Round	132 inch Round
30"	30" Round Top 30" Height	Full Drape	Puddle	Puddle	Puddle
36"	36" Round Top 30" Height	27" Drop	Puddle	Puddle	Puddle
48"	48" Round Top 30" Height	21" Drop	Full Drape	Puddle	Puddle
60"	60" Round Top 30" Height	15" Drop	24" Drop	Full Drape	Puddle
72"	72" Round Top 30" Height	9" Drop	18" Drop	24" Drop	Full Drape

Table Size		Tablecloth Size			
		BANQUET	BANQUET	90 x 132 inch Rectangular	90 x 156 inch Rectangular
6 ft.	72" L x 30" w x 30" H	15" Drop	Sides: 27" Drop Front & Back: 15" Drop	Full Drape	Puddle
8 ft.	96" L x 30" W x 30"H	Sides: 3" Drop Front & Back: 15" Drop	15" Drop	Sides: 18" Drop Front & Back: 30" Drop	Full Drape



CHAIRS

DISCOVER AN EXTENSIVE ARRAY OF RENTAL CHAIRS AT PARTY LINE RENTAL, CATERING TO THE NY TRI-STATE AREA! WHETHER YOU'RE IN NEED OF FOLDING CHAIRS, STACKABLE OPTIONS, STOOLS, BENCHES, OR MORE, WE'VE GOT YOU COVERED. SELECT YOUR IDEAL CHAIRS BASED ON STYLE, PRICE, COLOR, OR SPACE CONSIDERATIONS. ENJOY THE CONVENIENCE OF DELIVERY AND PICKUP SERVICES RIGHT TO YOUR HOME OR VENUE, ENSURING YOU RECEIVE IMPECCABLY MAINTAINED, HIGH-QUALITY SEATING. ELEVATE ANY OCCASION WITH CHAIRS AND BARSTOOLS FROM PARTY LINE RENTALS THAT YOU CAN TAKE PRIDE IN.



CHIAVARI BALLROOM CHAIR

<u>BLACK</u>	#0614
<u>FRUITWOOD</u>	#0137
<u>GOLD</u>	#0147
<u>SILVER</u>	#0611
<u>WHITE</u>	#0610

CHAIR: 16"D x 15.5W x 18"H



STANDARD CUSHIONS ARE AVAILABLE. WE HAVE A LARGE SELECTION OF CUSTOM COLOR CUSHIONS. CALL 914-592-1200 FOR MORE DETAILS!

X02 CROSSBACK CHAIR

CHAIR: 20.5"D x 19.7"W x 34.5"H
SEAT: 16"D x 17.5"W x 18.5"H

- #0613 ANTIQUE RUSTIC
- #0616 NATURAL WOOD



GHOST CHAIR



#0618

CHAIR: 18"D x 15"W x 35"H
SEAT: 15.5"D x 14.5W x 18" H

PLASTIC FOLDING CHAIR

<u>BLACK</u>	#0148
<u>BROWN</u>	#0141
<u>WHITE</u>	#0139



CHAIR: 17.5"D x 31"W x 16"H
SEAT: 15.5"W x 15.5"W x 17.5"H





GARDEN CHAIR

CHAIR: 17" L x 15" W x 31" H
SEAT: 16" W x 14.25" W x 17" H

<u>NATURAL WOOD</u>	#0136
<u>WHITE RESIN</u>	#0146
<u>BLACK RESIN</u>	#0138

CROSSBACK BAR STOOL



#0617 RUSTIC

CHAIR: 17" L x 19.5" W x 46" H
SEAT: 16" D x 17" W x 30" H

CHIAVARI BAR STOOL

<u>BLACK</u>	#0685
<u>FRUITWOOD</u>	#0612
<u>GOLD</u>	#0687
<u>SILVER</u>	#0629
<u>WHITE</u>	#0686



CHAIR: 15.5" W x 16" D x 29" H
SEAT: 16" W x 16" L x 29" H

CLASSIC BAR STOOL



#0119

CHAIR: 29" H x 21.5" W
SEAT: 14"

FOR MORE BAR RENTALS; SEE PAGE 76

DIRECTORS CHAIR



24" HIGH #0609

18" HIGH #0607

SEE PAGE 97 FOR MORE
FILM & PRODUCTION

FARM BENCH



#0627

8' L x 13" W x 19.5" H
SEATS 4 ADULTS

SEE PAGE 44 FOR OUR
RUSTIC COLLECTION

WOOD BENCH



#0132

6' L x 12" W x 18" H
SEATS 3 ADULTS

PEDESTAL BAR STOOL



PADDED SEAT #0640

POLY SEAT #0641

FOOT RING #0642

AVAILABLE

HIGH CHAIR



#118P | CHAIR: 20"H

CHIAVARI CHAIR



WHITE	#0144
BLUE	#0142
PINK	#0143
CLEAR	#4201

CHAIR: 12"L X 12"W X 25"H
SEAT: 12"L X 12"W X 13"H

FOLDING CHAIR



WHITE	#0140
BLUE	#140B
PINK	#140P
BLACK	#140x

CHAIR: 12.25"L x 7.25"W x 21.5"H
SEAT: 10.25" L x 7.25"W x 7"H

BOOSTER SEAT



#0145 | DUAL HEIGHT | PLASTIC

WHY MAKE THE CHILDREN SIT IN A CHAIR TWICE THEIR SIZE.

OUR CHAIRS ARE JUST RIGHT FOR YOUR CHILDREN! THESE CHAIRS ARE RECOMMENDED FOR AGES 2 TO 8.



#102c [CHALKBOARD TABLE](#)
6' x 30" | 22" HIGH

#0648 [PEDESTAL TABLE](#)
20" HIGH

CHOICE OF TABLETOP SIZE:
[24" ROUND TABLE #0116](#)
[30" ROUND TABLE #0113](#)



VISIT OUR DESIGN
CENTER TODAY!



#0102 [KIDS BANQUET TABLE](#)
6' x 30" | 22" HIGH
SEATS 8 KIDS



#0103 [KIDS ROUND TABLE](#)
42" ROUND x 22" LEGS



CHINA

INFUSE A TOUCH OF SOPHISTICATED AND REFINEMENT INTO YOUR UPCOMING EVENT. WHETHER YOU'RE PLANNING A WEDDING, CORPORATE GATHERING, OR ANY SPECIAL OCCASION, PARTY LINE RENTALS HAS THE PERFECT SOLUTION FOR YOUR CHINA, DINNERWARE, AND PLACE SETTING NEEDS. OUR RANGE INCLUDES A DIVERSE ARRAY OF RENTAL CHINA, DINNERWARE, AND PLACE SETTINGS TO SUIT YOUR PREFERENCES. WHETHER YOU DESIRE A CONTEMPORARY TWIST OR A CLASSIC TOUCH, WE HAVE IT ALL – FROM GOLD-RIMMED PLATES TO PORCELAIN CHINA. DIVE INTO OUR COLLECTION, ORGANIZED BY PRODUCT COLORS, PATTERNS, AND MATERIALS, TO FIND THE PERFECT COMPLEMENT FOR YOUR TABLE SETTING.



#0241 10" DINNER PLATE



#0242 8" SALAD | DESSERT PLATE



#0244 6" BREAD & BUTTER PLATE

BELLA COLLECTION

CRISP WHITE PORCELAIN WITH A BASKET WEAVE PATTERN IS A CLASSIC AND UNDERSTATED CHOICE THAT BEAUTIFULLY SHOWCASES YOUR FOOD.



#0249 12" ROUND PLATTER



#0248 9oz SUGAR BOWL | ALL PURPOSE



#0247 9" SOUP | SALAD BOWL



#0271 ESPRESSO SAUCER

#0270 2oz ESPRESSO CUP



#0245 7.5 oz CUP



#0246 SAUCER



#0243 8.5oz CREAMER PITCHER

ITEMS MAY UNDERGO ALTERATIONS. VISIT OUR SHOWROOM FOR PRECISE MATCHES. PRICES ARE SUBJECT TO CHANGE WITHOUT PRIOR NOTICE.



RHIANNON PLATINUM BAND COLLECTION

THIS CHINA COLLECTION IS A GREAT WAY TO MAKE A SUBTLE STATEMENT THAT WON'T OVERSHADOW THE EVENT OR OCCASION. EACH PIECE IS MADE OF HIGH QUALITY WHITE CHINA AND FEATURES PLATINUM BAND DETAILING.



#0633 7oz COFFEE CUP
#2634 SAUCER



#0635 SOUP BOWL



#0632 6.5" BREAD & BUTTER PLATE



#0631 7.75" SALAD | CAKE PLATE



#0630 10.75" DINNER PLATE

EXPLORE OUR **SHOWROOM DESIGN CENTER**,
WHETHER YOU'RE VIRTUALLY OR PHYSICALLY PRESENT!

VISIT US ONLINE AT **PARTYLINERENTALS.COM**
OR STOP BY OUR PHYSICAL LOCATION AT
1 NEPPERHAN AVENUE, ELMSFORD, NY.
WE CAN'T WAIT TO CONNECT WITH YOU!!



ITEMS MAY UNDERGO ALTERATIONS. VISIT OUR SHOWROOM FOR PRECISE MATCHES. PRICES ARE SUBJECT TO CHANGE WITHOUT PRIOR NOTICE.



#0211 13" SERVING PLATTER



#0190 12" BUFFET PLATE



#0200 10" DINNER PLATE



#0201 7" SALAD | DESSERT PLATE



#0202 6" BREAD & BUTTER PLATE



**GOLD ECRU
COLLECTION**



#0216 9oz SUGAR BOWL



#0205 12oz SOUP BOWL



#0206 7.5oz SOUP BOWL



#0215 CREAMER PITCHER



#0203 COFFEE CUP



#0204 COFFEE SAUCER

ITEMS MAY UNDERGO ALTERATIONS. VISIT OUR SHOWROOM FOR PRECISE MATCHES. PRICES ARE SUBJECT TO CHANGE WITHOUT PRIOR NOTICE.



SQUARE COLLECTION

THIS PLATE COMBINES SIMPLICITY AND STYLE TO ADD ELEGANCE TO YOUR TABLETOP. ITS CHIC, SQUARE DESIGN IS GREAT FOR SERVING MAIN ENTREES AND SHARED PLATTERS, WHILE THE CRISP, BRIGHT WHITE COLOR ENHANCES ANY STYLE OR COLOR OF TABLE LINENS, DINNERWARE ACCESSORIES, OR TABLE SETTINGS.



#0834 6" WHITE PLATE



#0833 7" WHITE PLATE



#0831 10.5" DINNER PLATE



#0838 10oz COFFEE MUG



#0839 BOWL 12oz



#0837 7oz CUP
#0838 WHITE SAUCER

VINEYARD COLLECTION

INFUSE THE DINING TABLE WITH THE GRACE OF OUR VINEYARD COLLECTION. ELEGANT COUPE PLATES ADORNED WITH INTRICATE GOLD AND SILVER LEAF DESIGNS EXUDE AN AURA OF TIMELESS SPLENDOR. WHETHER YOU'RE ORGANIZING AN INTIMATE DINNER OR AN EXTRAVAGANT HIGH TEA, OUR VINEYARD COLLECTION'S ADAPTABLE AESTHETIC EFFORTLESSLY ENHANCES ANY OCCASION.



#0847 6.25" BREAD & BUTTER PLATE



#0846 8" SALAD | DESSERT PLATE



#0845 10.5" DINNER PLATE

ITEMS MAY UNDERGO ALTERATIONS. VISIT OUR SHOWROOM FOR PRECISE MATCHES. PRICES ARE SUBJECT TO CHANGE WITHOUT PRIOR NOTICE.

COUPE COLLECTION



#0842 10.5" COUPE PLATE



#0843 8" COUPE PLATE



#7210 10.5" DINNER PLATE



#7211 8" SALAD PLATE

CLASSIC FLORAL COLLECTION

THE CLASSIC FLORAL PATTERN FEATURES COLORFUL FLOWERS AND FLOWER LEAVES, WITH GOLD ACCENTS ON WHITE DISHES.

CHINA FAQ

IS THE TABLEWARE DELIVERED FOOD-READY?

CERTAINLY, OUR TABLEWARE IS DELIVERED CLEANED, SANITIZED, AND READY FOR IMMEDIATE USE.

DO I NEED TO WASH THE PLATES AFTER USE?

NO, WE SIMPLY REQUEST THAT YOU SCRAPE OFF ANY FOOD DEBRIS FROM THE PLATES AND RINSE THEM BEFORE RETURNING THEM TO THE DELIVERY CONTAINER RACKS. OUR COMMITMENT TO USING COMMERCIAL DELIVERY EQUIPMENT FOR PLATES AND GLASSWARE ENSURES EFFORTLESS SETUP AND BREAKDOWN.

WHAT IS THE QUANTITY OF CHINA PLATES I CAN ORDER AT ONE TIME?

ALL CHINA IS RENTED BY THE DOZEN AND CONVENIENTLY PLACED IN RACKS FOR EASY PICKUP AND DELIVERY.

GET INSPIRED WITH OUR CHINA TABLETOP PHOTOS



GLASSWARE



#0322 BEVERAGE GLASS
9oz



#0289 BEVERAGE GLASS
12oz



#0335 FOOTED HIGHBALL
10oz



#0337 FOOTED HIGHBALL
8oz



#0345 STEMLESS RED WINE
21oz



#0346 STEMLESS WHITE WINE
11 1/4oz



#0325 MASON JAR w/ HANDLE
16oz



#0381 MASON JAR
16oz



#0409 WATER GOBLET
14oz



#0332 IRISH COFFEE MUG
8oz



#0268 STEM GLASS BOWL
4" x 4"



ICE CREAM SUNDAE GLASS
#0348



MARQUEE GOBLET
BLUE #7035



MARQUEE GOBLET
AMBER #7030



#0334 PUNCH CUP
6oz



#0310 MUG COPPER
16oz



ITEMS MAY UNDERGO ALTERATIONS.
VISIT OUR SHOWROOM FOR PRECISE
MATCHES. PRICES ARE SUBJECT TO
CHANGE WITHOUT PRIOR NOTICE.

WATER / WINE GLASS COLLECTION



#0339 8.5oz



#0338 10.5oz



#0320 12oz



#0440 15oz
GOURMET



#0343 15oz

CHAMPAGNE COLLECTION



#0329 FLUTE
5.75oz



#0330 TULIP
9oz



#0328 SAUCER
4.5oz

GOLD RIM COLLECTION



#7222 CHAMPAGNE FLUTE
7.3oz



#7220 ALL PURPOSE
15oz



#7221 WINE GLASS
10oz



#0347 MARGARITA GLASS
12oz



#0327 MARTINI GLASS
7.5oz



10.5oz #3324
9.75oz #3325



#0340 SHOOTER GLASS
2¼oz



#0321 CORDIAL GLASS
1.25oz



#0336 BEER MUG



#0341 PILSNER
12oz



#0323 BRANDY/COGNAC



CRYSTAL COLLECTION



CHARGER PLATE
13" x 13"
#7006



#7002 #7001
SQUARE CANDLE HOLDERS
4"W x 4"L x 7"H #7002
4"W x 4"L x 5"H #7001



#7009 #7008
CANDLE HOLDERS
SMALL #7008
LARGE #7009



VOTIVE—RIBBED GLASS
#7300



MOONGLOW LITE
#0176



FROSTED VOTIVE
#0177



PEBBLED GLASS
#7301



ANTIQUE CAKE STAND
10"W x 9"H #7020
16"W x 9"H #7021

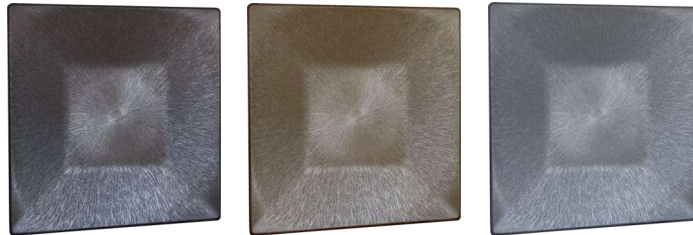

CHARGERS 12" x 12"
BLACK #0191 | GOLD #0193 | SILVER #0192



CHARGERS 14"
BLUE #0187



TABLE NUMBER HOLDER
8" #0283
12" #0294

*TABLE NUMBER CARDS
1-100 #6282
1-25 #6281



SALT AND PEPPER SET
MINI CUBE SET #0218
GLASS SET #0217



#0263 CYLINDER VASE
4"W x 4"L x 12"H



PILLAR VASES
3.5" x 6" #7205
3.5" x 7.5" #7206
3.5" x 9" #7207

ONEIDA ASTRAGAL



- SALAD | DESSERT FORK #0651
- DINNER FORK #0650
- DINNER KNIFE #0652
- TABLESPOON #0655
- TEASPOON #0654
- BUTTER KNIFE #0653
- BOUILLON SPOON #0656
- SOUP SPOON #0657
- DEMITASSE SPOON #0658
- ICE TEA SPOON #0659
- OYSTER FORK #0649

ONEIDA CHATEAU



- SALAD | DESSERT FORK #0152
- DINNER FORK #0151
- DINNER KNIFE #0155
- TABLESPOON #0161
- TEASPOON #0160
- BUTTER KNIFE #0157
- SOUP SPOON #0159
- DEMITASSE SPOON #0162
- ICED TEA SPOON #0154
- COCKTAIL FORK #0153

CAPRI GOLD



- SALAD | DESSERT FORK #7202
- DINNER FORK #7201
- DINNER KNIFE #7203
- TEASPOON #7204



VISIT OUR SHOWROOM LOCATED
AT 1 NEPPERHAN AVENUE
ELMSFORD NY TO EXPERIENCE
OUR ENTIRE CHINA COLLECTION
FIRSTHAND. WE LOOK FORWARD
TO SEEING YOU SOON!





KITCHEN AND CATERING

THE HALLMARK OF GREAT EVENTS? EXCEPTIONAL FOOD AND DRINKS. AT PARTY LINE RENTALS, WE OFFER A COMPREHENSIVE RANGE OF CATERING AND SERVING EQUIPMENT, INCLUDING GRILLS, WARMERS, BEVERAGE CONTAINERS, AND UTENSILS, TO HELP YOU CREATE THE ULTIMATE SPREAD FOR ANY OCCASION. CONTACT US, AND LET OUR EVENT SPECIALISTS GUIDE YOU THROUGH YOUR KITCHEN AND CATERING REQUIREMENTS.





#0408 **COFFEE DISPENSER**
100oz PUMP POT



#0401 **COFFEE MAKER**
101 CUPS



#0400 **COFFEE MAKER**
12-55 CUPS



#0410 **SERVER**
| 3 GALLON SAMOVAR | 50 CUPS
USED FOR HOT WATER, COFFEE, AND/OR TEA



#0220 **SUGAR BOWL**
12oz | STAINLESS



#0214 **CREAM PITCHER**
12oz | STAINLESS



#0300 **PITCHER**
64oz | STAINLESS STEEL



#0291 **COFFEE SERVER**
64oz | STAINLESS



#0296 **PITCHER**
64oz | INSULATED | WHITE



#0301 **PITCHER**
60oz | PLASTIC



#0295 **PITCHER**
44oz | GLASS



#0299 **PITCHER**
33.75 oz | GLASS



#0297 **PITCHER**
60oz | GLASS



5 Gallon 10 Gallon

CAMBRO BEVERAGE DISPENSER

5 GALLON #0795
10 GALLON #0796



#0840 **COFFEE MUG**
10oz



#0332 **IRISH COFFEE MUG**
8oz



#0342 **CARAFE**
1 LITER



#0354 **BEVERAGE FOUNTAIN**
5 GALLON CAPACITY
22"W X 24"H
CLEAR LIQUIDS ONLY



#0303 **BEVERAGE DISPENSER**
BRUSHED BASE
3 GALLON



#0294 **BEVERAGE DISPENSER**
WOOD BASE
4 GALLON



BEVERAGE DISPENSER
W/ ICE CHAMBER
3 GALLON #0302
5 GALLONS #0303

CHAFING DISHES



#0386 7 QUART LAFAYETTE
STAINLESS STEEL



#0391 4 QUART LAFAYETTE
STAINLESS STEEL



#0392 5 QUART
STAINLESS STEEL



#0383 7 QUART STANDARD
STAINLESS STEEL



#0380 8 QUART ROLLTOP
ROUND



#0382 8 QUART ROLLTOP
RECTANGULAR



#0467 HAMMERED CHAFER
HOLDS 1.75 QUARTS



#0397 ELECTRIC HEATER
IN LIEU OF OPEN FLAME STERNO



FOOD PAN—STAINLESS STEEL

- 2" FULL SIZE #0388
- 2" HALF SIZE #0390
- 4" FULL SIZE #0387
- 4" HALF SIZE #0389



ROUND PAN—STAINLESS STEEL

- 5 QUART #0393
- 8 QUART #0394



STEEL WIRE CHAFER RACK

#0395

FOR SALE ITEMS



ALUMINUM PANS AND LIDS

WE OFFER 2" & 4" FULL AND HALF SIZE ALUMINUM PANS AND LIDS FOR SALE.



PLASTIC TABLE COVERS

CALL FOR CURRENT COLOR SELECTION



#660 STERNO CHAFING FUEL



#0463 ELECTRIC PROOFING CABINET
 MAXIMUM CAPACITY 10 TRAYS
 110 VOLT 15 AMP UP TO 160°



#0431 TRUE REACH-IN REFRIGERATOR
 3 ADJUSTABLE SHELVES
 EACH SELF: 22 7/8" L x 23 1/4 D
 19.7 SUBIC FEET
 27" L x 30" W x 84" H
 120V | 60HZ | 7.6 AMPS
 300LBS ON CASTOR WHEELS
 **DELIVERY ONLY



PROOFING CABINET

#0458 SMALL | MAXIMUM CAPACITY 20 TRAYS
#0460 LARGE | MAXIMUM CAPACITY 35 TRAYS

#0457 CAMBRO FOOD CARRIER
 HOLDS FIVE 2.5" DEEP HOTEL PANS
 EXTERIOR: 24" L x 25" H x 17" W
 INTERIOR: 21" L x 17" H x 13" W
 LOSES 3° PER HOUR



FULL SIZE SHEET PAN
 18" x 26" | #0461



HALF SIZE SHEET PAN
 13" x 18" | #0462



#0464 BAKERS RACK

#0423 CARVING BOARD STATION
 COMES WITH LAMP & DRIP PAN
 120V | 250W



#0376 HEAT LAMP—SINGLE
 FOR CARVING STATION



#0375 WOOD CARVING BOARD
 20" x 16" x 1" | BUTCHER BLOCK



#0424 DUAL LAMP FOOD WARMER
 1/2 SHEET ELECTRIC | 1500 WATTS | 120V | 60HZ



SERVING TRAYS



BREAD BASKET
#0254

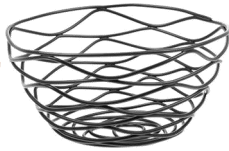

BREAD BASKET
#0253 7" BLACK ROUND



PUNCH BOWL
#0315



#0196 SERVING BOWL
12"W x 5"H | WHITE



#0377 OVAL PLATTER
16"L x 11"W



#0367 SERVING TRAY W/ HANDLES
12.5"W x 19.5"L



#0371 SERVING TRAY
16"W x 21"L



#0368 OVAL SERVING TRAY
19"L x 14"W



#0370 ROUND SERVING TRAY
15"W



#7116 FLAT RIM RECTANGLE TRAY
14"L x 7.5W x 1"H

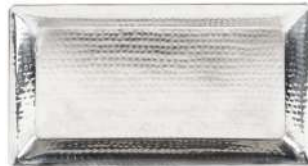

#7114 FLARED RIM RECTANGLE TRAY
16.5L x 11.25"W x .5H



SQUARE TRAY
16" | #7106
18" | #7108



#7102 BREAD ROLL TRAY
11"



#7101 HAMMERED OVAL TRAY
20"



#7104 FLARED RIM OVAL TRAY
11" x 15"



**ROUND TRAY
W/ CONICAL RIM**
13.5" | #7110



#0156 **PARING/FRUIT**
3"



#0491 **SERRATED**
10" | BREAD



#0494 **GRAPEFRUIT**
3"



#0158 **STEAK**
10"



#0492 **CHEF**
10"



#0167 **SPATULA**
8"



SPATULA
12" #0478



#0489 **SANDWICH SPREADER**



#0486 **CHEF'S THERMOMETER**



#499 **CAN OPENER**



#0474 **MEAT TENDERIZER**



#0475 **WHISK**



#499 **SEAFOOD CRACKER**



LADLE

- 1oz #0234
- 2oz #0235
- 4oz #0236
- 8oz #0237
- 12oz #0238



8OZ PUNCH LADLE
#0312



SERVING SPOON 13"
PERFORATED | #0165
SOLID | #0164



#0189 **SPOON**
SERVING



#0168 **SILVER SPOON**
8"



#0166 **FORK**
13"



#0178 **SILVER FORK**
8"



#0317 **ICE TONGS**
6"



#0179 **BREAD TONGS**
8"



TONGS
6" #0169
8" #0170



#0173 **SATIN TONGS**
9"





STAINLESS STEEL FOOD PREP TABLE

HEAVY DUTY COMMERCIAL KITCHEN TABLE

5' #0484



#0487 **COLANDER 15"**



SAUCE PAN WITH LID

4.5 QUART #0481
7.5 QUART #0482
10 QUART #0483



STOCK POT

24 QUART #0441
40 QUART #0438
60 QUART #0437
80 QUART #0439



STEAMER

24 QUART #441B
40 QUART #0442
60 QUART #0436



#0472 **BRAZIER**
24 QUART



#0485 **FRYING PAN**
7 QUART



#0393 **ROUND PAN**



#0393 **ROASTING PAN**



MIXING BOWL
18" #0470
10.5" #0471



STACKING BOWLS
5" #0266
10" #0267



PEBBLE BOWL
8" #0304
12" #0306
15" #0307
18" #0305
23" #0308



#0259 **RAMEKIN**
4.5oz #0259



2 TIER WROUGHT IRON STAND AND TRAY

STAND #0276
14" x 7" HAMMERED TRAY #0277

3 TIER WROUGHT IRON STAND AND BOWLS

STAND #0272
8" HAMMERED BOWL #0273
12" HAMMERED BOWL #0274
16" HAMMERED BOWL #0275

#7010 **4 TIER STAND**
6' HIGH | 16" DIAMETER
30" / 24" / 20"

#0278 **3 TIER WROUGHT IRON STAND**

#0279 **TRAY WHITE 14" x 7"**



#0364 **BUFFET BOAT**
5 QUART | 28"



#0365 **ACRYLIC ICE TRAY**
42"L x 24"W x 4"H



#0362 **FILL-N-CHILL TABLE**
4'L x 2'W x 30"H
INTERIOR: 44" x 20" x 3.5"
MAX CAPACITY 350 LBS.



#0363 **FILL-N-CHILL TABLE**
6'L x 2'W x 30"H
INTERIOR: 69" x 29" x 3.5"
MAX CAPACITY 500 LBS.



#0366 **SEAFOOD TRAY**
28"L x 18"W x 6"H





CHARCOAL GRILL

2' x 3' | #0448

2' x 5' | #0450

NEEDS 30-40LBS OF CHARCOAL TO START AND 10-15LBS OF CHARCOAL EACH HOUR WHILE THE GRILL IS IN USE

#0452 ELECTRIC ROTISSERIE

****FOR 2' x 5' CHARCOAL GRILL**

POWERFUL 1/20HP ELECTRIC MOTOR
RELIABLE CHAIN DRIVE EASILY TURNS UP TO 80LBS.

ROASTS AT 6 ROTATIONS PER MINUTES.

HOLDS UP TO 80LBS ROAST | REQUIRES 110V

NEEDS 30-40LBS OF CHARCOAL TO GET STARTED

WILL TAKE APPROXIMATELY 10-13 HOURS FOR AN 80LB ROAST



PROPANE GRILL

2' x 42' | #0454

2' x 6' | #0455

PROPANE SOLD SEPARATELY



#1203 ALUMINUM COOKTOP

6'W X 9.5H X 10'L

FIRE DEPARTMENT

BOARD OF HEALTH

APPROVED

GRILLING ACCESSORIES



PROPANE FILLING
STATION ON PREMISES.
WE WILL FILL UP YOUR
TANK AS WELL!

PROPANE TANKS

- 20LBS TANK
- 40LBS TANK
- 60LBS TANK
- 100LBS TANK



LIGHTER FLUID

2 QUART

BAG OF CHARCOAL

20LBS



#0183 **BBQ TONGS 18"**



#0181 **BBQ SPATULA 20"**



#0182 **BBQ FORK 20"**



#S1214 **GRILL BRUSH**



SIX BURNER RANGE WITH OVEN

#0432

40"L x 62"W x 41"H | 110V | 15AMPS



PROPANE CONVECTION OVEN MOFFET

#0429 **HALF SIZE**

39"L x 32"W x 47"H
115V | .24kw | 20 AMPS
HOLDS UP TO 10 FOOD PANS.



PROPANE CONVECTION OVEN

#0449 **FULL SIZE**

59"L x 51"W x 58"H
115V | 9.8/4.2 AMPS
HOLDS UP TO 20 FOOD PANS.

INCLUDES ADJ. LEVELING LEGS & LARGE CASTER WHEELS THAT CAN HANDLE ROUGH TERRAIN. PROPANE SOLD SEPARATELY. AVAILABLE FULLY ELECTRIC. 50 AMPS 3 PHASE SERVICE REQUIRED. ELECTRIC UNIT STYLE MAY VARY.



SINGLE BURNER BUTANE STOVE

1500 WATTS 120V 60HZ | #0419
8OZ CAN OF BUTANE | #0662



#0435 OPEN BURNER

PROPANE SOLD SEPARATELY
60K BTU | 19"W x 24"H x 22"D



#0443 CONVECTION OVEN

1/2 SHEET ELECTRIC
1500 WATTS | 120V | 60HZ



#0430 COMMERCIAL FLAT TOP GRIDDLE

PROPANE SOLD SEPARATELY | NO ELECTRICITY REQUIRED
44"L x 39"D x 42"H | 110V | 15AMPS



#0433 TABLETOP GRIDDLE

24" | PROPANE SOLD SEPARATELY



#0445 ELECTRIC DEEP FRYER

TABLETOP | 110V | 20AMPS



#0444 PROPANE DEEP FRYER

TAKES 40LBS OIL
REQUIRES "K" FIRE EXTINGUISHER
PROPANE SOLD SEPARATELY



#2640 PORTABLE HAND WASHING STATION

110V | 15AMP
 5 GALLON WATER TANK
 5 GALLON GREY WATER RESERVE
 BUILT-IN PAPER TOWEL AND SOAP DISPENSER



#2562 HANDWASH STATION ATTACHMENTS

COMPLETE WITH PAPER TOWEL AND SOAP DISPENSER
 (SUPPLIES NOT INCLUDED)
 JUST FILL THE #0795 BEVERAGE CONTAINER (RENTED SEPARATELY) WITH HOT WATER AND PLACE A PAIL UNDERNEATH TO CATCH THE WASTE WATER.



#2644 3 BAY PORTABLE WASH SINK

CONTAINS THREE 12 INCH DEEP BASINS TO WASH, RINSE AND SANITIZE COOKING UTENSILS
 CONTAINS TWO 5 GALLON TANKS FOR FRESH WATER AND TWO 8 GALLON TANKS FOR WASTE WATER
 INCLUDES 4.5 GALLON ELECTRIC OR PROPANE POWERED WATER HEATER
 PROPANE SOLD SEPARATELY.



GARBAGE CAN

32 GALLON #0787
 45 GALLON #0788



SLIM JIM GARBAGE CAN

23 GALLON #0792



#2560 PURELL HAND SANITIZING STATION

HAND SANITIZER REFILL #135



#0374 **WAITERS TRAY**
27" | OVAL



#0373 **WAITERS TRAY**
18" | ROUND



#0372 **WAITERS TRAY STAND**



#0379 **BUS PAN**
PLASTIC | 7"



#0396 **CAFETERIA TRAY**



PLATE COVER
TAN SMALL #0222
GREY LARGE #0223



WORK LINENS & BAR TOWELS

EXPLORE OUR EXTENSIVE SELECTION OF BANQUET LINENS DESIGNED FOR YOUR CULINARY SPACES—AN ESSENTIAL FOR CATERERS AND PARTY PLANNERS!





BAR AND BARWARE

ELEVATE YOUR EVENT TO THE NEXT LEVEL WITH OUR EXQUISITE BAR AND BARWARE COLLECTION. EACH ITEM IN THIS VERSATILE RANGE EXUDES ITS OWN DISTINCT CHARM, OFFERING ENDLESS POSSIBILITIES FOR BEVERAGE SERVICE, FOOD STATIONS, OPEN BARS, CAPTIVATING DISPLAYS, AND BEYOND!

UNLEASH YOUR MIXOLOGY SKILLS, POUR WINE WITH FINESSE, AND SPOTLIGHT YOUR SIGNATURE DRINKS USING OUR BAR AND ACCESSORIES. WITH PARTY LINE RENTALS, YOU CAN EFFORTLESSLY OPEN, MIX, CHILL, SHOWCASE, AND SERVE ANY BEVERAGE ON YOUR MENU BY CHOOSING FROM OUR EXCEPTIONAL SELECTION OF BAR EQUIPMENT FOR RENT.





#4941 STRAIGHT SECTION: 53" L x 44" H x 35" W

#4942 90° CORNER SECTION: 30" L x 44" H x 36" W



#4948 ICE BIN WITH SPEED RAIL



#4950 BACK BAR SHELF UNIT

38" x 76"



#4750 BACK DISPLAY

60" W x 79" H

**BLACK HEAD BOARD OPTIONAL





ICE SCOOPER
#0960



ICE TONGS 6"
#0317



COCKTAIL SHAKER
#0575



WINE ICE BUCKET
#0360
8 QUART STAINLESS STEEL



WINE ICE BUCKET & STAND
#0356
4 QUART STAINLESS STEEL



#0574 BAR BLENDER
1 QT. | STAINLESS STEEL



#0290 BAR CADDY
4 COMPARTMENTS FOR ALL
YOUR COCKTAIL GARNISHES



GLASS CARAFE
#0342 | 1 LITER



#0301 BAR PITCHER
PLASTIC | 60OZ



GLASS PITCHER
8oz. #0298
34oz. #0299
44oz. #0295
60oz. #0297



ICE CHEST
42-55QT #0319
100-150QT #0316



IGLOO COOLER
5 GALLON #0790
10 GALLON #0791



#0798 SUPER COOLER—KEG
EFFICIENTLY COOLS WITH ONLY
3 BAGS OF ICE!



#0361 ICE BEVERAGE TUB
STAINLESS STEEL HAMMERED

MOST POPULAR GLASSES!



MARTINI GLASS
#0327 | 7.5oz



OLD FASHION ROCKS
#3324 | 10.5oz



SHOOTER GLASS
#0340 | 2¼oz



BRANDY/COGNAC
#0323



BEER MUG
#0336



MARGARITA GLASS
#7300 | 12 oz

PORTABLE FOLDING BAR

CUT-OUT HANDLES ON THE SIDES FOR EASY TRANSPORTATION.
WORK-SPACE SHELF FOLDS DOWN ALLOWING SIDES TO FOLD FOR FLAT STORAGE.

TOP SHELF LIFTS OUT OF THE SIDE BRACKETS FOR EASY REMOVAL.

- 4 FT—PEWTER #0569
- 6 FT—PEWTER #0573
- 4 FT—WHITE #569w
- 6 FT—WHITE #0571



ROLLING BARS



#0570 ROLLING BAR WITH ICE BIN

63" W X 42" H X 20" D

24" STAINLESS STEEL BIN HOLDS 95 LBS. OF ICE

24" REMOVABLE STAINLESS STEEL SPEED RAIL

OPTIONAL SKIRT ADDITIONAL



WE ALSO CARRY BAR SEATING. SEE PAGE 50





FURNITURE | DÉCOR

FOR YOUR CORPORATE EVENTS, WEDDINGS, FESTIVALS, GOLF OUTINGS, OR CONCERTS, PARTY LINE RENTALS HAS THE IDEAL RENTAL FURNITURE FOR YOUR SPECIFIC OCCASION. EXPLORE OUR VAST ASSORTMENT, RANGING FROM CHAIRS AND TABLES TO SECTIONALS AND BANQUETTES. WHETHER YOUR EVENT IS INTIMATE OR GRAND IN SCALE, OUR EXTENSIVE INVENTORY OF RENTAL FURNITURE IS CRAFTED TO CATER TO LOCAL PREFERENCES, ENSURING A PERFECT FIT FOR EVENTS OF ALL SIZES.



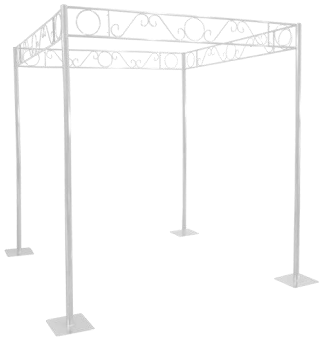

#0510 CHUPPAH
7' x 7' x 8' | WHITE



#0500 ARCH
50'L x 32"W x 84"H



#0504 ARBOR
4'9"L x 2'W x 7'4"H



WEDDING CANOPY
PIPE AND DRAPE



#4990 WINE BARREL
23"W x 37"H



#4722 BARREL TOPPER
40" ROUND

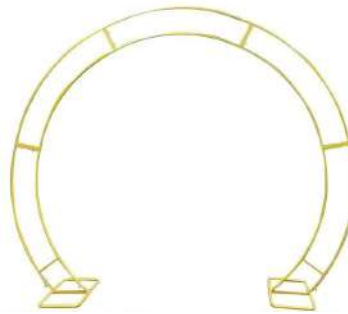

WEDDING ARCH
GOLD #7060



WEDDING ARCH
#0505

TAKE A LOOK AT OUR RUSTIC COLLECTION! SEE PAGE 44



BOXWOOD SPHERE
11" #4704
15" #4703
21.5" #4702



#4710 SCREENING
4' x 8'



#4712 WINDOW LATTICE SCREEN
39" x 78"



BOXWOOD HEDGES
48"L x 24"W x 36"H #0513
36"L x 24"W x 72"H #0514





#0588 PICKET FENCE
6' x 42"



BI-FOLD DIVIDER
80"H x 36"L
BLACK #0516
WHITE #0515



PIPE AND DRAPE
CUSTOM COLORS AVAILABLE
8' | 10"



LIGHTED TREE
WOOD BRANCHES
36"H #7052
95'H #7050



LIGHTED TREE
GOLD BRANCHES
3' #4951
4' #4952



#0521 WEDDING PARASOL



#0520 WISHING WELL
29"H x 13"W | BASKET 11.5" D



#0523 THRONE CHAIR
BRIDAL CHAIR



#0523 BLING CHAIR
27.5"L x 22"W x 56"H



#0524 CHILD'S PRINCESS CHAIR



#0522 PEACOCK CHAIR

WE ALSO OFFER MORE SEATING OPTIONS. VISIT PAGE 48



#4973 AXIS OTTOMAN



#4971 AXIS CORNER CHAIR



#4972 AXIS CHAIR



OTTOMAN COVERS

SILVER #4978
WHITE #4977



#4930 LOUNGE BLOCK TRAY TOP



SHORT LOUNGE BLOCK

17" HIGH
WHITE #4932
BLACK #4933



TALL LOUNGE BLOCK

24" HIGH
WHITE #4931
BLACK #4934

THREE PIECES—HUNDREDS OF CONFIGURATIONS

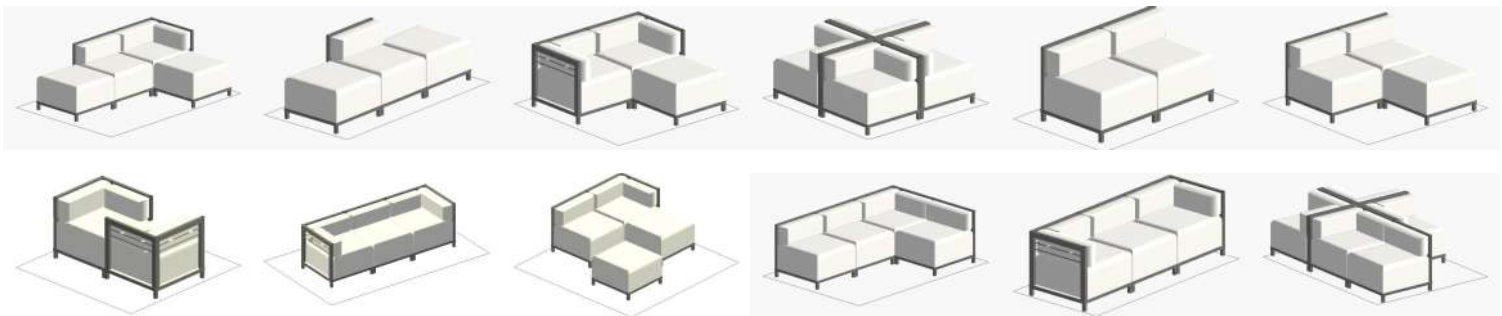

EXPLORE OUR **SHOWROOM DESIGN CENTER**,
WHETHER YOU'RE VIRTUALLY OR PHYSICALLY PRESENT!

VISIT US ONLINE AT **PARTYLINERENTALS.COM**
OR STOP BY OUR PHYSICAL LOCATION AT
1 NEPPERHAN AVENUE, ELMSFORD, NY.
WE CAN'T WAIT TO CONNECT WITH YOU!!



HOW DO YOU CHOOSE CLIMATE CONTROL FOR YOUR NEXT EVENT?

THE ONLY THING MORE MISERABLE THAN A FREEZING COLD EVENT MAY BE A HOT AND STUFFY ONE. IN EITHER SCENARIO, YOUR GUESTS WILL BE DISTRACTED BY THEIR DISCOMFORT. THE RIGHT CLIMATE CONTROL KEEPS GUESTS FOCUSED ON YOUR EVENT EXPERIENCE INSTEAD OF HOW UNCOMFORTABLE THEY ARE.

CLIMATE CONTROL CAN TAKE MANY FORMS: HEATERS, COOLING STATIONS WITH MISTERS, AND TRADITIONAL HVAC UNITS. WHEN CHOOSING CLIMATE CONTROL FOR YOUR EVENT, THE LOCATION AND VENUE SIZE WILL DETERMINE WHAT YOU NEED.

WHETHER YOUR EVENT TAKES PLACE UNDER A TENT, IN A BARN OR IN THE MIDDLE OF A FIELD, PARTY LINE RENTALS CAN GUARANTEE TO KEEP YOUR GUESTS COMFORTABLE AND HAPPY. WE OFFER CLIMATE-CONTROLLED TENTS FOR EVENTS OF ANY SIZE OR BUDGET. OUR CLEAR SPAN STRUCTURES ARE GREAT FOR RETAIL SPACES AND HIGH-PROFILE EVENTS, AND OUR FRAME TENTS CAN BE SET UP ABOUT ANYWHERE. CUSTOM SOLUTIONS ARE OUR SPECIALTY, JUST LET US KNOW WHAT YOU NEED AND WE WILL GET IT DONE FOR YOU!

AIR CONDITIONING AND COOLING:

ENCLOSED SPACES; EVAPORATIVE COOLERS OR PORTABLE AIR CONDITIONERS WILL KEEP GUESTS COOL AND COMFORTABLE.

OUR MOST POPULAR OPTIONS ARE:

TENT FANS: PLACE IN CORNERS OR ATTACH TO SUPPORT POLES TO IMPROVE AIRFLOW WITHIN THE TENT.

OSCILLATING PEDESTAL FAN: CAN BE EASILY MOVED ANYWHERE ADDITIONAL AIR CIRCULATION IS DESIRED

MISTING FANS: ENHANCE COOLING BY SPRAYING A LIGHT MIST OF WATER

OUTDOOR EVENTS IN THE SUN: WE RECOMMEND A TEMPERATURE-CONTROLLED TENT WHERE YOUR GUESTS CAN TAKE A BREAK FROM THE SUN AND RELAX IN A COOL ENVIRONMENT.

OUTDOOR EVENTS IN THE SHADE: OPTIMIZE NATURAL SHADE WITH COOLING STATIONS FEATURING MISTING FANS, CREATING A RELAXING AREA FOR GUESTS TO GATHER. THESE STATIONS CAN BE CONVENIENTLY SET UP NEXT TO A BUILDING OR UNDER AN OPEN TENT.

HEATING:

ENSURE INDOOR WARMTH WITH OUR ELECTRIC HEATERS, SIMPLE TO INSTALL AND MOVE, SUITABLE FOR EVENTS OF ANY SIZE.

ENHANCE OUTDOOR COMFORT WITH FREE-STANDING PATIO HEATERS, ALLOWING GUESTS TO CONTROL THEIR HEAT LEVEL BY ADJUSTING PROXIMITY.

CONSIDER THE ATTRACTIVE ADDITION OF PROPANE HEATERS FOR OUTDOOR EVENTS. NO ELECTRICITY REQUIRED!



CLIMATE CONTROL

PARTY LINE RENTALS PROVIDES A VARIETY OF CLIMATE CONTROL SOLUTIONS TO GUARANTEE YOUR GUESTS' COMFORT WITHIN OUR RENTAL TENTS YEAR-ROUND. OUR OFFERINGS INCLUDE HEATING, AIR CONDITIONING, FANS, AND DEHUMIDIFIERS, ALLOWING PRECISE TEMPERATURE CONTROL REGARDLESS OF THE EXTERNAL WEATHER CONDITIONS, WHETHER IT'S WARM, COLD, HUMID, OR RAINY. WE OFFER BOTH INDIRECT AND PROPANE HEATING, ALONG WITH COOLING SYSTEMS FEATURING COMPREHENSIVE SAFETY MEASURES, INCLUDING ENCLOSED FLAMES AND ELECTRONICS. FOR ADDED CONVENIENCE, THESE UNITS COME WITH REMOTE THERMOSTATS, MAKING IT EFFORTLESS TO MANAGE THE TEMPERATURE INSIDE YOUR TENT RENTAL.





#0789 CLAMP ON TENT FAN

MOUNTS DIRECTLY ONTO TENT LEG
GREAT FOR CIRCULATING AIR WITHOUT
IMPEDING THE MOVEMENT OF YOUR GUESTS



#0780 CEILING FAN 42"

BEST IN LARGE TENTS WITH HIGHER PEAKS.
WORKS BY DRAWING HOT AIR UP AND
AWAY FROM YOUR GUESTS.



#0777 PEDESTAL FAN
30" | STATIONARY



#2089 PEDESTAL FAN
24" | OSCILLATING



#0778 FLOOR FAN
42" | STATIONARY
HIGH POWER AIR MOVER



#2086 MISTING FAN
18" | 5 GALLON
OSCILLATING



EVAPORATIVE COOLERS

1HP #2088

1/2 HP #2087

HOW THEY WORK: EVAPORATIVE COOLERS SERVE AS A COST-EFFECTIVE MIDDLE GROUND BETWEEN FANS AND CONVENTIONAL AIR CONDITIONING. THE PROCESS UNFOLDS AS FOLLOWS: THE COOLER AUTOMATICALLY FILLS UP VIA A GARDEN HOSE CONNECTION AT THE REAR OF THE UNIT. ABSORBENT PANELS ON THE MACHINE'S SIDES DRAW WATER FROM THIS SOURCE. FRESH AIR IS THEN DRAWN IN, PASSING THROUGH THE MOISTENED PANELS. ULTIMATELY, A POWERFUL FAN PROPELS THE COOL, MOISTENED AIR OUTWARD FOR A REFRESHING EFFECT.

**TO ACCESS DETAILED INSTRUCTIONS FOR
EVAPORATIVE COOLER, SCAN THE QR CODE!**





#2131 **1.5 TON AC UNIT—PORTABLE**
 19.3”w x 48.3”h x 23.6”l | 185LBS
 110V | 20 AMPS | SINGLE PHASE



#2113 **5 TON AC UNIT—NARROW**
 29.5”w x 54.5”h x 67”l | 690LBS
 220v | 50 AMPS | 3 PHASE



#2114 **12 TON AC UNIT**
 19.3”w x 48.3”h x 23.6”l | 185LBS
 220V | 50 AMPS | 3 PHASE



#2112 **20 TON AC UNIT**
 95”w x 99”h x 66”l | 3200LBS
 460V | 78 AMPS | 3 PHASE



#2104 **20 TON AC UNIT**
 91.63w x 94.1h x 36l | 2600LBS
 220v | 50 AMPS | 3 PHASE

AIR CONDITIONING PACKAGES:

- 5 TON #2106
- 10 TON #2107
- 15 TON #2108
- 20 TON #2109

PACKAGES INCLUDES:

- AIR CONDITIONER (S)
- DUCTING
- THERMOSTAT
- GENERATORS & CABLES

FINAL PRICING WILL BE BASED ON THE SPACE REQUIREMENTS.
 ALL A/C UNITS REQUIRE A GENERATOR AND A TECHNICIAN ON SITE.

****LARGE PACKAGES AVAILABLE. CALL FOR DETAILS**



AIR CONDITIONED TENTS





RHINO PATIO HEATER COLLAPSIBLE

BLACK #2140

BRONZE #2141

BTU: 41,000
 HEIGHT: 8'
 10' RADIUS OF COMFORTABLE HEAT
 20LBS PROPANE TANK * RENTED SEPARATELY
 20LBS OF PROPANE WILL LAST UP TO 8 HOURS

FOR OUTDOOR USE ONLY
NOT AVAILABLE FOR CUSTOMER PICKUPS

DO NOT WORRY, WE
 DELIVER TO THE
 NY TRI-STATE AREA.
 CALL (914) 592-1200 TO
 FIND OUT MORE DETAILS.



LAVA LIGHT PATIO HEATER

#0773

BTU: 56,000
 HEIGHT: 7'9"
 5' RADIUS OF COMFORTABLE HEAT
 20LBS PROPANE TANK * RENTED SEPARATELY
 20LBS OF PROPANE WILL LAST UP TO 8 HRS.

FOR OUTDOOR USE ONLY
NOT AVAILABLE FOR CUSTOMER PICKUPS



ZUBRI PATIO HEATER

#0783

BTU: 40,000
 HEIGHT: 7'3"
 10' RADIUS OF COMFORTABLE HEAT
 20LBS PROPANE TANK * RENTED SEPARATELY
 20LBS OF PROPANE WILL LAST UP TO 6 HRS.

FOR OUTDOOR USE ONLY
AVAILABLE FOR CUSTOMER PICKUPS

SCAN FOR PATIO HEATER INSTRUCTIONS!



PATIO UMBRELLA

7.5' #0126

ROUND BASE #126B



GOLF UMBRELLA

BLACK | 45" #0681



MARKET UMBRELLA

9' #0954

11' #0127

SQUARE BASE #0683



42" - 72" ROUND TABLES BEST FIT OUR UMBRELLA COLLECTION.
 SEE PAGE 42 FOR MORE IDEAS
 CALL (914)592-1200 FOR MORE INFORMATION.



PROPANE



#0781 **80K BTU HEATER**

USES 3.7 LBS. OF PROPANE PER HOUR



#0785 **170K BTU HEATER**

USES 7.9 LBS. OF PROPANE PER HOUR



#2090 **350K BTU HEATER**

USES 16.2 LBS. OF PROPANE PER HOUR



#0781 **40K BTU HEATER**

USES 1.5 LBS. OF PROPANE PER HOUR



#0771 **30K BTU HEATER**

USES 1 LBS. OF PROPANE PER HOUR



#0786 **18K BTU HEATER**

USES .8 LBS. OF PROPANE PER HOUR

ELECTRIC



#2119 **60KW HEATER**

73AMP | 3 PHASE | 480V
205,000 BTU



#2098 **20KW HEATER**

50AMP | 3 PHASE | 240V
60,000 BTU



#2790 **9KW HEATER**

38AMP | SINGLE PHASE | 220V
30,700 BTU



#0782 **1.5KW HEATER**

15AMP | SINGLE PHASE | 120V
5,100 BTU

INDIRECT



#0784 **100K BTU**

USES .8 GAL. OF FUEL PER HOUR
TANK HOLDS 17.2 GALLONS



#2092 **300K BTU**

USES 2.2 GAL. OF FUEL PER HOUR
TANK HOLDS 27.7 GALLONS



#2091 **500K BTU**

USES 3 GAL. OF FUEL PER HOUR
TANK HOLDS 42 GALLONS



#2093 **700K BTU**

USES 5 GAL. OF FUEL PER HOUR
TANK HOLDS 175 GALLONS

MOST HEATERS REQUIRE A LARGE POWER SOURCE AND MUST USE A DEDICATED OUTLET FOR HEATER.

LARGE POWER DISTRIBUTION PACKAGE

GREAT FOR POWERING YOUR LARGER EVENTS AIR CONDITIONING, FANS, HEATERS, LIGHTS, CATERING, AND BANDS.

THIS PACKAGE INCLUDES:

- GENERATOR
- DISTRIBUTION BOX
- CAM-LOCK CABLES
- EXTENSION CORDS
- CORD ADAPTERS

**FUEL ADDITIONAL CHARGE



SMALL POWER DISTRIBUTION PACKAGE

GREAT FOR POWERING YOUR SMALLER EVENTS AIR CONDITIONING, FANS, HEATERS, LIGHTS, CATERING, AND BANDS.

THIS PACKAGE INCLUDES:

- GENERATOR
- DISTRIBUTION BOX
- CAM-LOCK CABLES
- EXTENSION CORDS
- CORD ADAPTERS

**FUEL ADDITIONAL CHARGE



CAM LOCK CABLES



#2019	10' KIT
#2020	25' KIT
#2017	50' KIT
#2036	100' KIT



INLINE DIMMER SWITCH

2,000 W #0554
1,000 W #0551



#2115 LIGHT TOWER

4K WATT DIESEL
6,000 WATT STANDBY OUTPUT
PRIME FUEL CONSUMPTION
0.47GPH
30 GALLON CAPACITY
64 HOUR RUN CAPACITY
360 LIGHT ROTATION
30' HIGH MAXIMUM EXTENSION



#0988 3 WAY CORD ADAPTER



EXTENSION CORDS 12/3

#0986 10'
#0985 25'
#0980 50'
#0981 100'



CAMLOCK POWER DISTRO BOX

#2083 SINGLE PHASE | 3 CIRCUITS | 50 AMP
#2015 PASS THRU | 10 CIRCUITS | 100 AMP
#2011 GROUND FAULT | 15 CIRCUITS | 100 AMP



#2006 CABLE RAMPS

36" HEAVY DUTY 5 WIRE
CAN WITHSTAND UP TO 16,300 LBS.



#2085 2KW GENERATOR

GAS | SUPER QUIET

1.1 GALLON TANK | 4.4 HRS. | 47LBS



#0954 3KW GENERATOR

GAS | SUPER QUIET

3.4 GALLON TANK | 7.2 HRS. | 135LBS



#2004 6.5KW GENERATOR

GAS | SUPER QUIET

4.5 GALLON TANK | 4.7 HRS. | 210LBS

TOWING IS REQUIRED FOR MOST GENERATORS. CONTACT US FOR DELIVERY PRICING.



#2120 GENERATOR
10KW | SINGLE PHASE | DIESEL
50 AMP MAIN BREAKER



#2125 GENERATOR

150KW | 3 PHASE | DIESEL
350 AMP MAIN BREAKER

#2120 GENERATOR

125KW | 3 PHASE | DIESEL
300 AMP MAIN BREAKER

#2001 GENERATOR

65KW | 3 PHASE | DIESEL
175 AMP MAIN BREAKER

#2003 GENERATOR

25KW | 3 PHASE | DIESEL
75 AMP MAIN BREAKER

Kw/Kva	150 kw/125
FUEL CAP	215 GAL
RUN TIME@100%	25 HOURS
SINGLE PHASE 120V	361 AMP X 2
SINGLE PHASE 240V	361 AMP
THREE PHASE 208V	394 AMP
THREE PHASE 240V	361 AMP
THREE PHASE 480V	180 AMP

Kw/Kva	110 kw / 137
FUEL CAP	198 GAL
RUN TIME @ 100%	27.5 HOURS
SINGLE PHASE 120V	300AMP X 2
SINGLE PHASE 240V	300 AMP
THREE PHASE 208V	328 AMP
THREE PHASE 240V	300 AMP
THREE PHASE 480V	150 AMP

Kw/Kva	67 kw / 53.6
FUEL CAP	106 GAL
RUN TIME @ 100%	27.8 HOURS
SINGLE PHASE 120V	152AMP X 2
SINGLE PHASE 240V	152 AMP
THREE PHASE 208V	167 AMP
THREE PHASE 240V	152 AMP
THREE PHASE 480V	76 AMP

Kw/Kva	22kw/27.5
FUEL CAP	51.5 GAL
RUN TIME@100%	32.1 HOURS
SINGLE PHASE 120V	60 AMP X 2
SINGLE PHASE 240V	60 AMP
THREE PHASE 208V	60 AMP
THREE PHASE 240V	60 AMP
THREE PHASE 480V	30 AMP





CONCESSION EQUIPMENT

ENHANCE THE ENJOYMENT AT YOUR SCHOOL AND CARNIVAL GATHERINGS, MAKE BIRTHDAYS, BACKYARD BARBECUES, COMPANY PICNICS, AND EMPLOYEE APPRECIATION EVENTS EVEN MORE MEMORABLE WITH OUR CONCESSION EQUIPMENT. OUR COLLECTION IS SURE TO DELIGHT AND SATISFY.





****POPCORN BAGS**



****8oz POPCORN FOR 10PPL**



BLACK POPCORN MACHINE

KETTLE 8OZ #420B
CART #421B



RED POPCORN MACHINE

KETTLE 8OZ #0420
CART #0421



****SUGAR FLOSS**

FEEDS 60-70PPL

****COTTON CANDY CONES**



COTTON CANDY MACHINE

#0425



COTTON CANDY BUBBLE

PINK #425P
BLUE #425B



COTTON CANDY CART

#0418



MILKSHAKE CUP

28OZ
#2823



MILKSHAKE MACHINE

13"W x 23"H
#2822



FROZEN DRINK MACHINE

MINI | 1-1.5 GALLONS
#0411



FROZEN DRINK MACHINE

SINGLE | 2.5 GALLONS
#0412



COME VISIT OUR SHOWROOM LOCATED AT 1 NEPPERHAN AVENUE ELMSFORD NY 10523





MIN. 8 BAGS OF CHOCOLATE TO GET STARTED



MIN. 3 BAGS OF CHOCOLATE TO GET STARTED



MONTEZUMA CHOCOLATE FOUNTAIN

18.5"W x 34"H | SERVES 150+ GUEST
#0350

CORTEZ CHOCOLATE FOUNTAIN

13"W x 23"H | SERVES 50-75 GUEST
#0351

WIND GUARD

PROTECTION FROM WIND
#350w

****CHOCOLATE BAGS**

MILK #12051
DARK #12052

CHOCOLATE SOLD SEPARATELY. UNIT MUST BE CLEANED IMMEDIATELY AFTER USE!



SNO-KONE MACHINE (FULL)

TAKES 1 BAGS OF ICE
#0426



SNO-KONE MACHINE

#0427

SNO-KONE CART

#426c

****SNO-KONES**
6OZ CUP | 32 Pcs.
#0618



****SNO-KONE SYRUP**
CALL FOR CURRENT FLAVORS

EXPLORE OUR **SHOWROOM DESIGN CENTER**, WHETHER YOU'RE VIRTUALLY OR PHYSICALLY PRESENT!

PARTY LINE RENTALS OFFERS AN INNOVATIVE APPROACH TO EVENT PLANNING, ALLOWING YOU TO DESIGN YOUR NEXT GATHERING FROM THE CONVENIENCE OF YOUR OWN SPACE. TAKE A 3D TOUR TO PREVIEW SOME OF OUR AVAILABLE RENTAL PRODUCTS, SIMPLY CLICK ON THE ITEMS YOU LOVE AND ADD THEM TO YOUR CART.

VISIT US ONLINE AT **PARTYLINERENTALS.COM** OR STOP BY OUR PHYSICAL LOCATION AT **1 NEPPERHAN AVENUE, ELMSFORD, NY.** WE CAN'T WAIT TO CONNECT WITH YOU!





PRETZEL WARMER
#0417 | 110V



ICE CREAM SUNDAE GLASS
#0348



ICE CREAM SCOOPER
#0349



**ICE CREAM CART W/
UMBRELLA**
#0428



HOT DOG ROLLER
18 HOT DOG CAPACITY | 110V
#0413



HOT DOG CART—TABLETOP
INCLUDES: 110V, 1 LARGE BAY,
2 SMALLER BAYS



HOT DOG CART W/ UMBRELLA
INCLUDES: 1 LARGE BAY AND
2 SMALLER BAYS
#0415



SCAN FOR MORE
DETAILS!



SCAN FOR MORE
DETAILS!



FUNNEL CAKE RING
#2818



FUNNEL CAKE PITCHER
#2817 | 28oz



FUNNEL CAKE MACHINE
110V | NEEDS 20 AMP CIRCUIT
#2815

PRODUCTION CHECKLIST

OUR TENTS ARE REQUIRED TO PRIORITIZE FUNCTIONALITY OVER AESTHETICS, PARTICULARLY IN THE CASE OF FILM AND TV PRODUCTION TENTS. THESE TENTS PLAY A CRUCIAL ROLE ON THE SETS OF TV SHOWS AND MOVIES, AS WELL AS AT EVENTS WHERE A CAST OF INDIVIDUALS REQUIRES ACCOMMODATIONS FOR STAYING AND PREPARING. IN SUCH SITUATIONS, OUR PRIMARY GOAL IS TO DELIVER OPTIMAL FUNCTIONALITY AND CONVENIENCE FOR OUR CLIENTS.

TENT

EXPLORE THE PERFECT PRODUCTION TENT SOLUTION BY ADDRESSING KEY CONSIDERATIONS WITH OUR SERIES OF INITIAL QUESTIONS:

1. WHAT IS THE ACCOMMODATION REQUIREMENT IN TERMS OF THE NUMBER OF PEOPLE?
2. ARE THERE ANY SPECIFIC SOCIAL DISTANCING MEASURES THAT NEED TO BE TAKEN INTO ACCOUNT?
3. WILL THERE BE A NEED FOR TABLES, CHAIRS, OR ANY OTHER TYPES OF FURNITURE?
4. DO YOU PREFER A TENT WITH WALLS OR DOORS?

THESE QUESTIONS SERVE AS THE FOUNDATION FOR DETERMINING THE REQUIRED SQUARE FOOTAGE AND THE OVERALL AREA SIZE. BY COMBINING THIS DATA WITH LOCATION PARAMETERS, WE ASSESS AND RECOMMEND THE OPTIMAL SIZE AND QUANTITY OF TENTS TO MEET YOUR UNIQUE SPECIFICATIONS. .

LIGHTING

REGARDLESS OF WHETHER YOUR TENT HAS WALLS, LIGHTING IS LIKELY A NECESSITY. PRODUCTION TENTS OFTEN ENDURE EXTENDED PERIODS OF USE, AND FACTORS LIKE EARLY MORNINGS, LATE NIGHTS, OR OVERCAST DAYS MAKE RELYING SOLELY ON NATURAL LIGHT CHALLENGING. EVEN TENTS WITH WALLS REQUIRE ADDITIONAL LIGHTING FOR OPTIMAL COMFORT. WE OFFER VARIOUS LIGHTING OPTIONS TAILORED TO YOUR NEEDS AND TENT SPECIFICATIONS.

FLOORING

INSTALL A FLOOR ON ANY SURFACE EFFORTLESSLY. IT IS STRONGLY ADVISED TO USE FLOORING, ESPECIALLY ON GRASSY AREAS, AS WEATHER AND HIGH FOOT TRAFFIC CAN LEAD TO A MESSY SITUATION. WE OFFER A VARIETY OF FLOORING OPTIONS TO SUIT YOUR NEEDS. ADDITIONALLY, IF THE TERRAIN IS UNEVEN, WE CAN ASSIST BY INSTALLING A SUBFLOOR TO CREATE A FLAT AND LEVEL WORKING SURFACE.

AIR CONDITIONING AND HEATING

DEPENDING ON THE SEASON AND ANTICIPATED WEATHER CONDITIONS, THE NEED FOR AC OR HEATING MAY ARISE. OUR USER-FRIENDLY AC/HEATING UNITS COME WITH ON-SITE DEMONSTRATIONS FOR THE CREW BEFORE THE FIRST DAY OF USE. THE AIR CONDITIONING UNITS ARE GENERATOR-POWERED, INCLUDED IN OUR COMPREHENSIVE PACKAGE. FOR OUR LARGER HEATERS, THEY TYPICALLY RUN ON FUEL, ELIMINATING THE NEED FOR A SEPARATE GENERATOR. ADDITIONALLY, WE OFFER ON-CALL REFUELING SERVICES FOR THE HEATERS AS REQUIRED.

POWER

WE SUPPLY POWER FOR ALL RENTED EQUIPMENT, INCLUDING LIGHTING AND AC/HEATING UNITS. OUR TEAM IS ALSO READY TO ASSIST WITH ANY LAST-MINUTE REQUIREMENTS TO ENSURE A SEAMLESS EXPERIENCE.

FIRE AND SAFETY

WE SUPPLY ALL REQUIRED FLAME CERTIFICATES TO STREAMLINE THE PERMITTING PROCESS, CERTIFYING THE FLAME RETARDANCY OF OUR EQUIPMENT. INSIDE THE TENT, WE OFFER COMPREHENSIVE FIRE SAFETY PACKAGES, FEATURING EXIT SIGNS, FIRE EXTINGUISHERS, AND EMERGENCY LIGHTS FOR ENHANCED SAFETY MEASURES.

WE ARE ALWAYS HAPPY TO HELP!



GOTHAM



FILM AND TV PRODUCTION

EXPLORE THE POSSIBILITIES WITH PARTY LINE, WHERE CHALLENGES BECOME OPPORTUNITIES IN THE REALM OF FILM AND TV PRODUCTIONS. WHILE OTHER COMPANIES ASSERT, "IT CAN'T BE DONE," WE CONFIDENTLY RESPOND, "WHY NOT? WE CAN DO THAT!"

WE GRASP THE DYNAMIC NATURE OF PRODUCTION DEMANDS, SEAMLESSLY NAVIGATING EARLY MORNING DELIVERIES, LATE-NIGHT PICKUPS, UNFORESEEN LAST-MINUTE CHALLENGES, AND CATERING TO SPECIAL REQUESTS. AT PARTY LINE, WE EMBRACE THE FLUIDITY OF THE INDUSTRY, ENSURING YOUR VISION IS REALIZED WITHOUT COMPROMISE.

CRAFT SERVICES
MAKEUP & HAIR
WARDROBE
PRIVACY
CROWD CONTROL
SAFETY

SUPPORTING
OVER 2,000
PRODUCTIONS





#3620 DELUXE SOUND SYSTEM KIT

CONNECT YOUR MUSIC THROUGH BLUETOOTH, CD TRAY OR 3.5MM AUDIO JACK

INCLUDES:

- 2 SPEAKERS
- 2 STANDS
- 1 MALE TO MALE
- 2 WIRELESS MICROPHONES
- 2 WIRELESS LAPELS
- 1 SPEAKER CORD
- 1 POWER CORD

#3612 COMPACT SOUND SYSTEM KIT

PLUG YOUR IPOD, SMARTPHONE, OR OTHER DEVICE RIGHT INTO THE AUDIO JACK

(THIS IS NOT WIRELESS AND JACK CONVERTOR NOT INCLUDED)

INCLUDES:

- 1 SPEAKER
- 1 STAND
- 1 MALE TO MALE
- 1 WIRELESS MICROPHONE
- 1 WIRELESS LAPEL
- 1 SPEAKER CORD
- 1 POWER CORD



#3613 MICROPHONE SET
WIRELESS



#3612 MICROPHONE AND LAPEL KIT
WIRELESS



#3603 MICROPHONE CORD



#3604 SPEAKER CABLE



#3605 MICROPHONE
STANDARD | HAND HELD



#3608 MICROPHONE STAND



#3602 SPEAKER



#3603 SPEAKER STAND



INTERLOCKING STEEL BLOCKADES

8'L X 42"H #0589

6'L X 42"H #0593

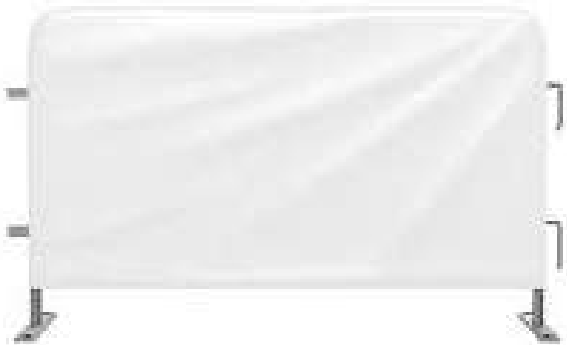

#0592 BARRICADE VINYL COVER

8' | WHITE

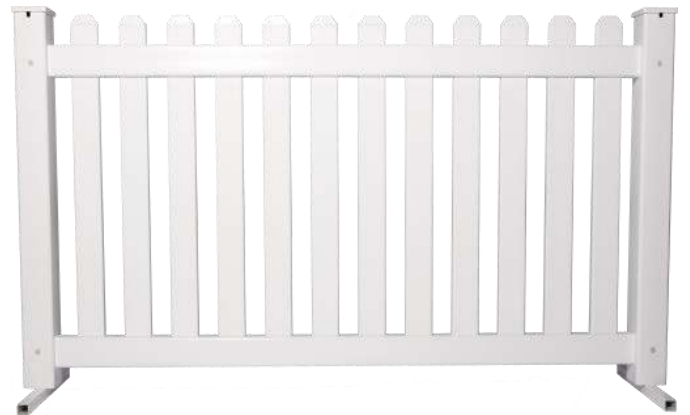

#0588 PICKET FENCE

6' X 42"



#0591 TRAFFIC CONE



#2512 WHITE SNOW FENCE
ALSO AVAILABLE IN ORANGE & GREEN



#1221 JERSEY BARRIER

10' LONG | 4K LBS.



STANCHIONS



RETRACTABLE STANCHION
#0584



CHROME STANCHION
#0585



RED VELVET ROPE 8'
#0586



BLACK VELVET ROPE 8'
#0587



#0912 **8' HIGH**
#0880 **10' HIGH**

KIT INCLUDES:

- BASES
- UPRIGHTS
- CROSSBARS
- DRAPES

GREAT FOR

- PARTY DÉCOR
- WEDDINGS
- ROOM DIVIDER
- TRADE SHOW BOOTHS
- CHANGING ROOM
- VOTING AREAS
- PHOTO BACKDROPS

CUSTOM COLORS ARE AVAILABLE—VISIT OUR SHOWROOM DESIGN CENTER FOR CURRENT SELECTIONS!

PIPE AND DRAPE



WHITE
3' HIGH #0904
8' HIGH #0915



IVORY
8' HIGH #0920



ROYAL BLUE
8' HIGH #0905



BLACK
8' HIGH HEAVY VELOUR #0901
10' HIGH VELOUR #0885



#0929 HAIR AND MAKEUP STATION

INCLUDES:
TABLE MIRROR
CHAIR POWER STRIP



MAKEUP CHAIR

24" #0606
25" #0600



DIRECTORS CHAIR

18" #0607
30" #0309



#0928 MIRROR

TABLETOP | DIMMABLE
16.5"W x 20"H



#0927 MIRROR

FULL LENGTH
20"W x 49"H x 65"L



STAGING

OUTSIDE | INDOOR
TIERED STAGING



FLOORING

ARMOUR DECK
DURADECK | ULTRADECK

SEE PAGE 29 FOR MORE STAGING & FLOORING OPTIONS



RECTANGULAR FOLDING TABLE

30" x 70" #0104
30" x 96" #0868



ROUND FOLDING TABLES

48" #0865
60" #0866



FOLDING CHAIRS

BLACK #0148
BROWN #0141
WHITE #0139



HEATING/COOLING SOLUTIONS

AIR CONDITIONING UNITS
GENERATORS
FANS | HEATERS

EXPLORE OUR DIVERSE RANGE OF TABLES ON PAGE 40!

DISCOVER MORE HEATING & COOLING OPTIONS ON PAGE 84!



#2560 HAND SANITIZER STATION

1200 + USE



#2640 HAND WASHING STATION

HOT WATER | 110V

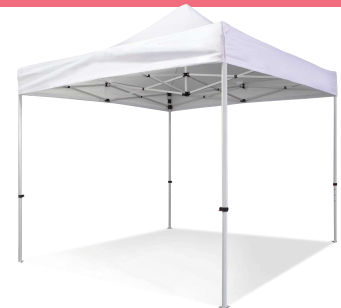

#0960 POP UP TENT

10' x 10'





#0506 BULL HORN
15 WATT BATTERY OPERATED



#0503 CEREMONIAL SCISSORS
24" GOLD



RAFFLE DRUM
SMALL #0501
LARGE #0502



#2870 PRIZE WHEEL
30" | MULTI-COLOR



DISPLAY EASELS
GOLD #0580
BLACK #0581



#0511 BLACK PODIUM
INCLUDES BUILT IN
MICROPHONE STAND



#0508 CLEAR PODIUM
COMES WITH SHELF



#0643 MUSIC STAND
ADJUSTABLE HEIGHT 24" - 42"



#0675 COAT RACK
HOLDS 40-60 GARMENTS



COAT HANGER
CHROME #0676
WIRE #0678



**** COAT CHECK NUMBERS**
100 COUNT
#S650

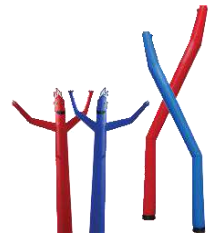

SKY TUBE DANCER
BLUE #2442
RED #2441



#0526 PROJECTOR SCREEN
8' x 8'
PROJECTOR NOT INCLUDED



FLAG
AMERICAN FLAG #0937
NEW YORK STATE FLAG #0938



BI-FOLD DIVIDERS
WHITE #0515
BLACK #0516

WE DELIVERY TO THE NEW
YORK TRI-STATE AREA.
CALL (914) 592-1200
OR VISIT US AT
PARTYLINERENTALS.COM!





#2115 **LIGHT TOWER**
30' HIGH MAXIMUM EXTENSION



#2427 **MESSAGE BOARD**
SOLAR POWERED | 126" x 76"



FORKLIFT
SMALL #0501
LARGE #0502



#9530 **TELEHANDLER**
19' | 5500 LBS.



#9041 **LITTLE GIANT LADDER**
5-9/17'



#9238 **AERIAL LIFT**
31' x 46" x 90"



#0242 **PERSONAL LIFT 25'**



#0243 **BOOM LIFT 62'**



MOVING BLANKET
#9028



4 WHEEL MOVING DOLLY
#9020



WAREHOUSE FLAT CART
#9024



MATERIAL LIFT 650#
#0430



HAND TRUCK
#9021|#9022

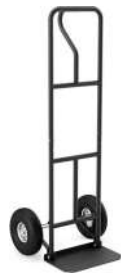

#9055 **HAND TRUCK MEGA MOVER**
GRANITE



#9026 **PALLET JACK**
5K CAPACITY



#0000 **GREEN MONSTER**
HYDRAULIC STAKE PULLER



WTRRENTALS.COM OR (914) 592-2016
FOR MORE RENTAL EQUIPMENT





DIALING UP THE FUN! PARTY LINE RENTALS IS ON THE MOVE, TURNING EVERY OCCASION INTO A LIVELY AFFAIR. GET READY FOR YOUR EVENT THAT RINGS WITH EXCITEMENT!

BACKYARD TO BLACKTIE